Cross Country Series
**Straight Lean To
Model**

GREENHOUSE INSTRUCTIONS



Manufactured for:



Contents

Foreword	2
User Notes	2
List of Drawings	3
Cross Country Straight Series Component List	4
Foundations	5

Assembly of the Aluminum Frame

A. Back Gable-End Assembly With Door	6
B. Front Gable-End Assembly	8
C. Sidewall Assembly	11

Aluminum Frame Installation

1. Side Wall	13
2. Side Wall To Front Gable-End	13
3. Side Wall to Back Gable-End	13
4. Ridge	13
4A. Truss Assembly Installation (If Necessary)	See Appendix A
5. Poly Bar With Sliders (#1 or #2)	14
6. Vent Frame Angle	14
7. Poly Bars	14
8. Roof Purlin	12
9. Taping Poly Bars with Foam	14
10. Fastening & Sealing Greenhouse	14
11. Side Vents, Intake Shutter and Exhaust Fan Installation (if necessary)	See Appendices B through G

Polycarbonate and Cap Installation

General Information About Handling Polycarbonate	21
12. Roof Polycarbonate Panel Installation	21
13. Back/Front Gable-Ends	22
14. Sidewalls	23
15. Sealing The Greenhouse	24

Door And Vent Installation

16. Door Installation	24
17. Vent Assembly	26
18. Vent Installation	26

Appendices: Optional Installations

Truss	Appendix A
Vent Opener	Appendix B
Intake Shutter	Appendix C
Exhaust Fan	Appendix D
Glass Louvre	Appendix E
Side Vent	Appendix F

Foreword

Your Cross Country greenhouse is designed and constructed to the highest engineering standards and provides structural strength and maintenance-free service for year-round gardening pleasure.

The Cross Country greenhouse must be built upon a firm, level surface. The greenhouse foundation or sill can be made from pre-treated timbers, concrete or bricks. Whatever your choice of material, the base must be square and level.

When selecting a site for your greenhouse, keep in mind that a flat, level site is essential so that the greenhouse can be easily installed and the complete structure is stable and secure. If possible, choose a site with proper water drainage.

Locating the greenhouse in a north-south position is most suitable for raising summer and autumn crops since the sun's rays will be on the greenhouse from daybreak until sunset. An east-west position is ideal for early spring and winter crops since the winter months, with shorter daylight hours, still allow six hours of light exposure to the greenhouse.

Try to locate your greenhouse for easy access, especially to the necessary power and water that is required for greenhouse gardening.

Please watch the enclosed video and follow the steps in this manual for your greenhouse installation. *Remember, if all else fails, read the instructions.*

User Notes

The Cross Country greenhouse structure has been designed to withstand extreme weather conditions such as high winds and accumulated snowfall. Hanging baskets and sidewall shelving can also be attached to its sturdy frame. The greenhouse design also makes it possible to add extra sections at a later date.

Sealing the polycarbonate sheets to the aluminum "H" and base is optional, however we highly recommend it. Eliminating any water from entering the inside of the aluminum, will prevent excessive moisture inside the panels.

Once a year the greenhouse needs to be completely washed inside and out. You should do this task when your greenhouse contains the least number of plants, generally just before the garden plants are brought in for wintering over. A recommended cleaning solution is a mixture of soap and water, this will not damage your polycarbonate sheets. Any benches, shelving, plastic trays, pots and baskets should also be cleaned thoroughly. *Prevention is the best known method for controlling pests and diseases in the greenhouse.*

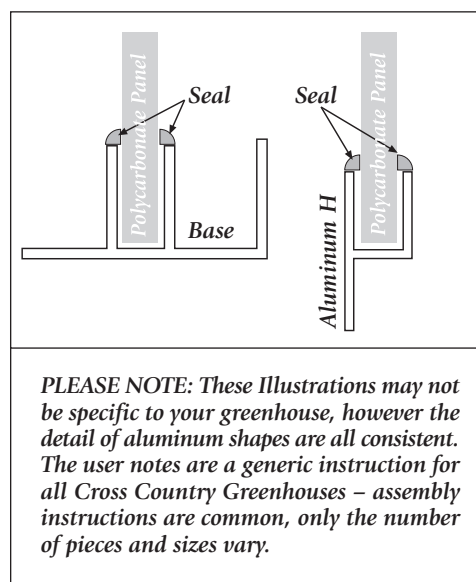

NOTE: DO NOT STORE POLYCARBONATE SHEETS IN THE SUN.

List of Drawings

Cross Country Straight Lean To Component List	4
Foundation Styles	5
Back Gable End Line Drawing Assembly Procedure	6
Back Gable End Detail Drawing – <i>Details 1 – 4</i>	7
Front Gable End (With Door) Line Drawing Assembly Procedure	9
Front Gable End (With Door) Detail Drawing – <i>Details 5 – 10</i>	10
Assembly Outline: Aluminum Frame Steps 1 – 10	13 - 20
Polycarbonate Installation Steps 12 – 14	21 - 24
Door Installation	25
Vent Assembly - Exploded View	28
Truss Assembly	Appendix A
Vent Opener	Appendix B
Intake Shutter	Appendix C
Exhaust Fan	Appendix D
Glass Louvre	Appendix E
Side Vent	Appendix F

Cross Country Component List

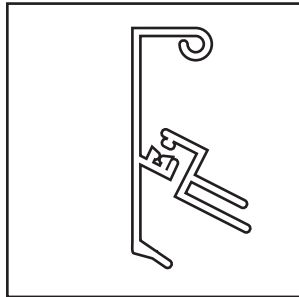

Ridge & Ridge Slider

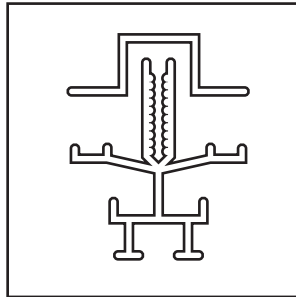

Poly Cap & Poly Bar

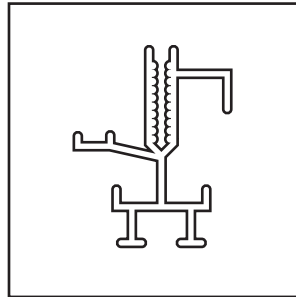

Poly End Bar

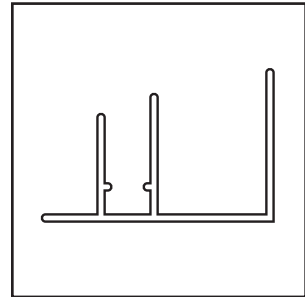

Ventframe Bottom Side Base/Sill

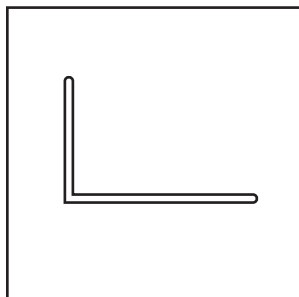

Bracing Angle

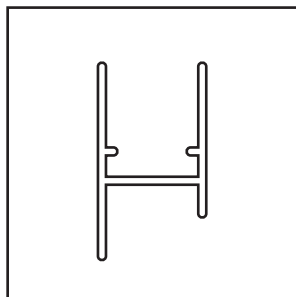

Aluminum H

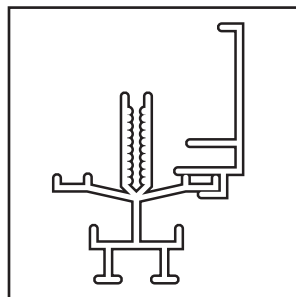

Vent Frame Sides

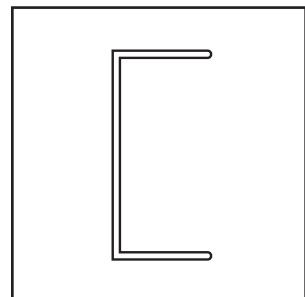

Purlin



Bolts / Nuts / Screws

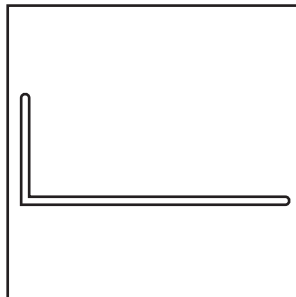

Front & Back Base/Sill

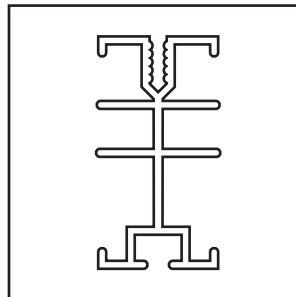

Door Frame

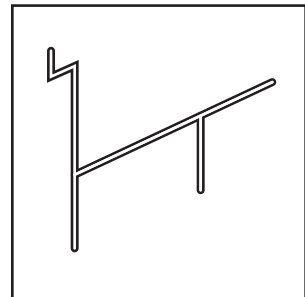

Gutter

Tools

- #2 Square head screw driver (#8 Screw)
- Measuring tape
- Level to check foundation
- 3/16" concrete bit (concrete foundation)
- 9/64" aluminum bit
- 7/16" wrench
- Razor blade cutter
- Caulking gun
- Ladder
- Hammer

Optionals

- Automatic Opener
- Circulating Fan
- Max/Min thermometer
- Benches
- Eyebolts
- Motorized Intake Shutter
- Exhaust Fan
- Thermostat
- Heater
- Side Vent

Foundations

Check your local building codes for foundation requirements in your area.

CONCRETE FOUNDATIONS

When you prepare the concrete foundation, the size should be 1" longer and wider than the greenhouse's outside dimensions. One option is to fasten a treated 4" x 4" wooden sill on top of the foundation. This sill is the exact outside dimensions of the greenhouse.

PRE-TREATED WOOD FOUNDATIONS

A greenhouse that is approximately 100 sq. ft. (9.3 m²) can be fastened to a 4" x 4" pre-treated wood timber foundation. For larger greenhouses, a 6" x 6" wood timber foundation is recommended. These timbers are placed on a 4" (10 cm) deep and 8" (20 cm) wide gravel bed. Wood timbers can be stacked to increase the height of the greenhouse. *One advantage of the wood foundation is that it is not classified as a permanent structure. Therefore, if you move, the greenhouse can be dismantled and moved to another location.*

A SQUARE AND LEVEL FOUNDATION

Check the width and length of the foundation's outside dimensions. Then, square the foundation by measuring diagonally from opposite corners in the form of an "X". Next, use a long carpenter's level to check and adjust the foundation until it is level. Finally, measure where the door will be placed (in most cases it is 34¹/₂" wide). Mark these measurements on your foundation.

Foundation Styles

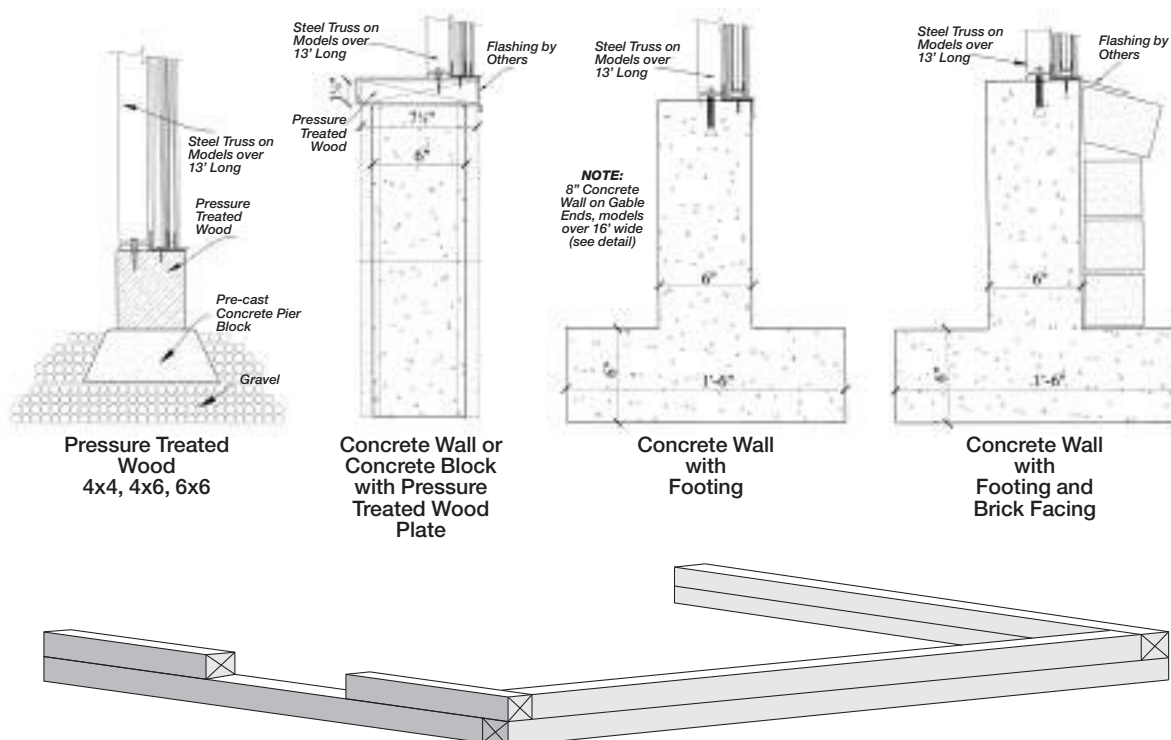

PRE-TREATED WOOD FOUNDATION

Assembly of Aluminum Frame

A. BACK GABLE END ASSEMBLY

Lay out the back pieces into the shape of the end wall. *Refer to the line/detail drawing.*

1. For the Poly End Bar (roof), the flat surface should lie on the ground (*See the example to the right*).
2. Bolt the Poly Bars on the top first (*See Detail #1 & 1A, Page 7*).
3. Bolt the base/sill to the bottom of the Poly Bars (*See Detail #2, Page 7*).
4. The angle brace is bolted approximately 56" up from the base. When bolting the horizontal cross brace onto the back wall, don't worry about exact height, when the greenhouse is bolted together, you will see an angle that is fastened to a side bar that will give you the exact height.



Back Gable End Line Drawing Assembly Procedure



Poly End Roof Bar

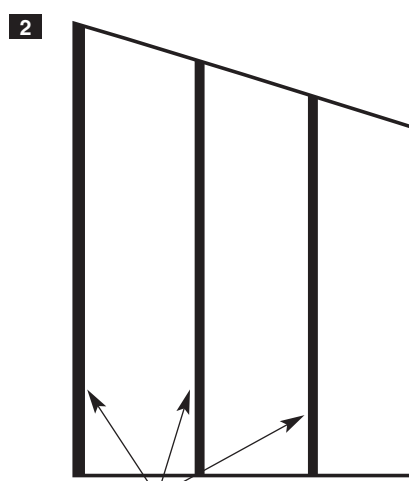

Poly Bars

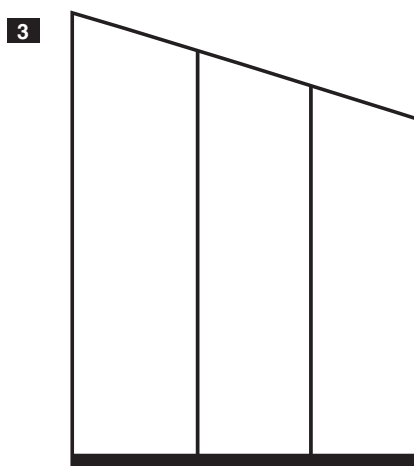

1" x 2" Angle Base

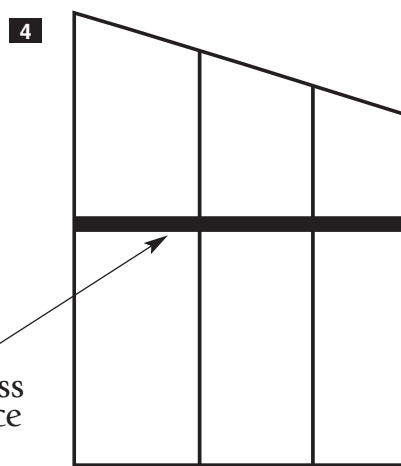

Cross Brace

Back Gable End Detail Drawing – Details 1 – 4

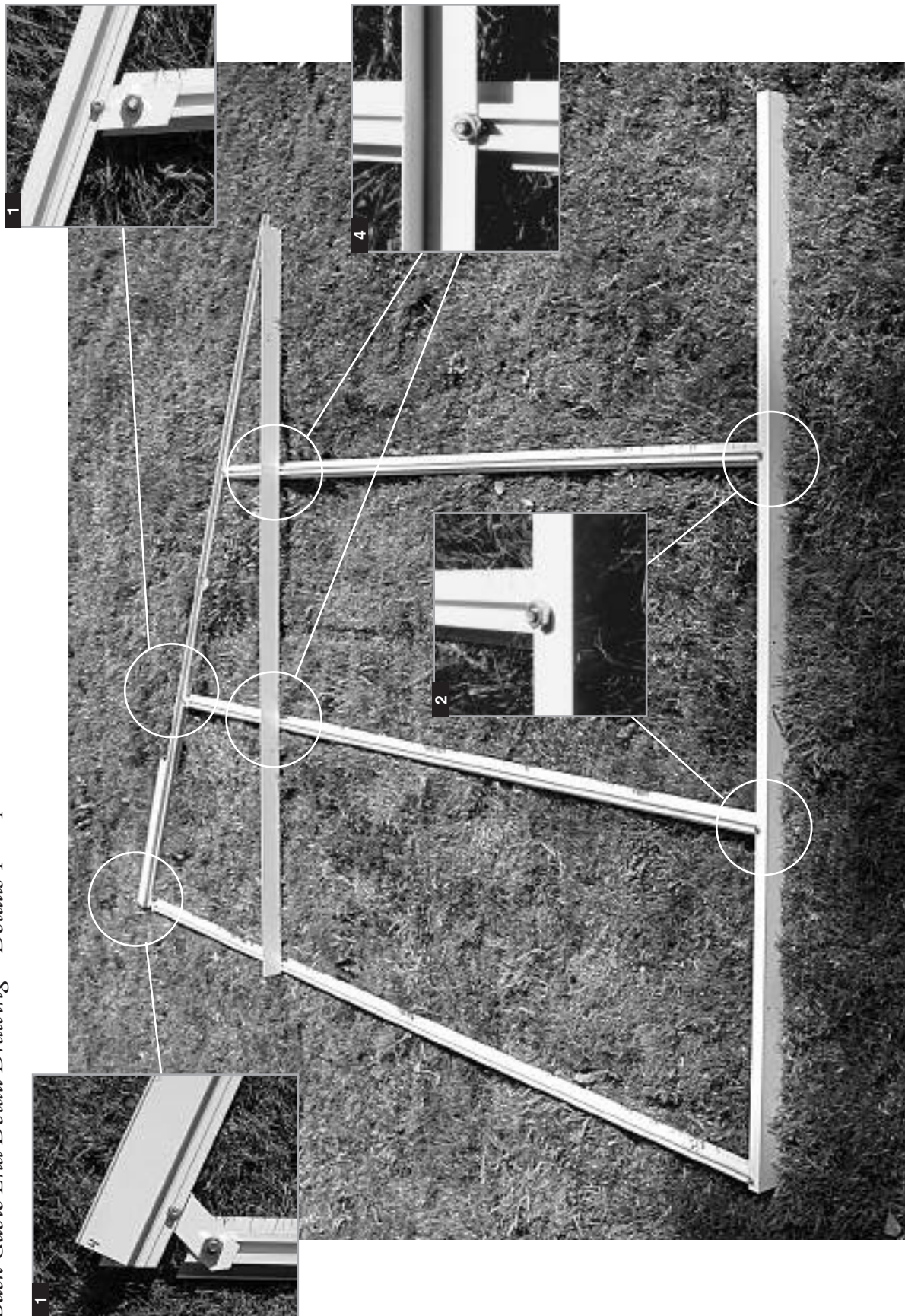

B. FRONT GABLE END ASSEMBLY WITH DOOR

1. Lay out the front pieces of the greenhouse into the shape of an end wall. The door frame and all the Poly Bars have a track for the bolt. The track must face up when you assemble the gable ends. Slide the bolts into the track of the bars or use the notches that have already been punched out in the bars. *(Refer to the line/detail drawing on the following page. The order of assembly is represented by dark lines. Detailed pictures are on page 10.)* When you are assembling the greenhouse, you view the sketches and drawings from the inside the greenhouse. Bolt the bottom plates (4 holes) to the base/sill and the door frame sides using 1/4" x 1/2" stainless steel bolts *(see Detail #5)*. Before tightening the bolts, be sure that it is square (If you ordered a greenhouse with a door drop, measure from the bottom of the door frame to the underside of the base according to the specified distance).
2. At the top of the door frame, put on the door frame header (which looks the same as the side pieces). Put the header between the two side pieces and bolt on the plates (6 holes). *(See Detail #6)*. The plates should stick up 1" above the door frame. Note how the plates are put on *(See Detail #7)*. Before tightening the bolts, be sure to square up the sill to the door frame.
3. Take all the Poly Bars and bolt them to the base/sill. The angle cut should match the roof slope *(See Detail #8)*.
4. The 1" x 2" angle above the door (50" long) can now be bolted on. The 1/4" round holes should be lined up with the holes in the plates. Each end of the 1" x 2" angle has a slot punched out to accommodate the bolt. This slot lines up with the bolt track in the back side of the Poly Bars. Slide a bolt in the top of the Poly Bar and fasten the angle to it *(See Detail #6 & 9)*.
5. **Roof Poly End Bar.** Each poly end bar has at least one small aluminum bracket attached to it with a 1/4" hole drilled in it. These pieces line up with the upright Poly Bar(s) *(See Detail #6 & #9)*
6. When the upright Poly Bars are fastened to the aluminum bracket that is attached to the poly end bar, bolt on the short Poly Bar above the door to the 1" x 2" angle.
7. The diagonal bracing can now be bolted on. Remove the bottom nut in the top plate and insert the brace. Then put the nut back on *(See Detail #4)*. Bolt the other end to the 1/4" hole in the base using a 1/4" x 1/2" bolt *(See Detail #10)*.

NOTE: *You may want to fasten a temporary brace across the bottom of the door frame to keep them together. This can be a piece of wood, make sure that the opening is the same as on the top of the door frame.*

Front Gable End (with door) Line Drawing Assembly Procedure

1

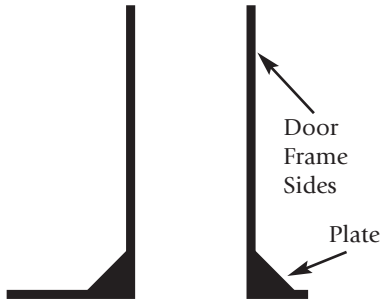

2

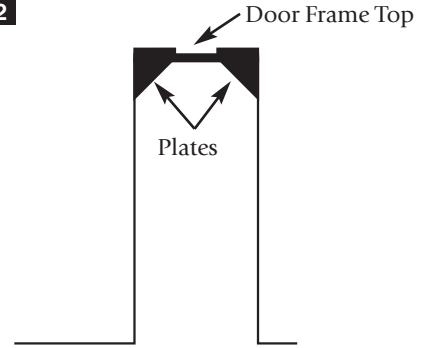

3

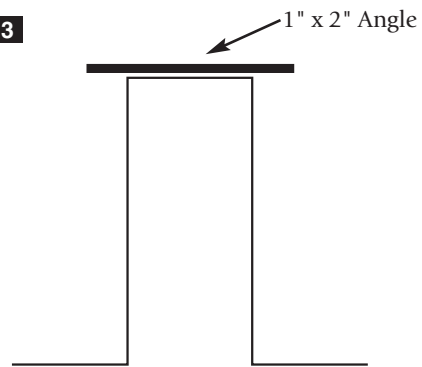

4

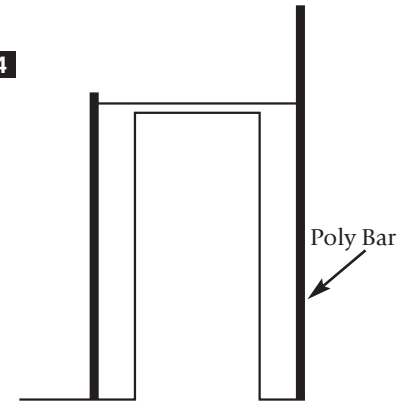

5

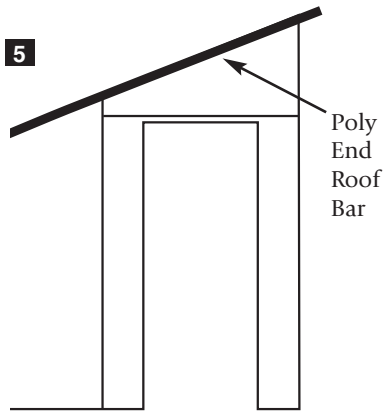

6

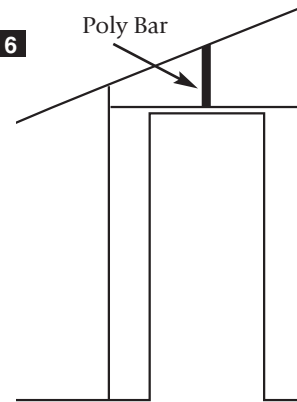

7

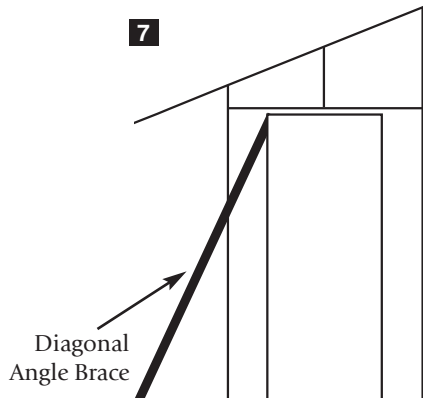

Front Gable End (with door) Detail Drawings Details 5 – 10

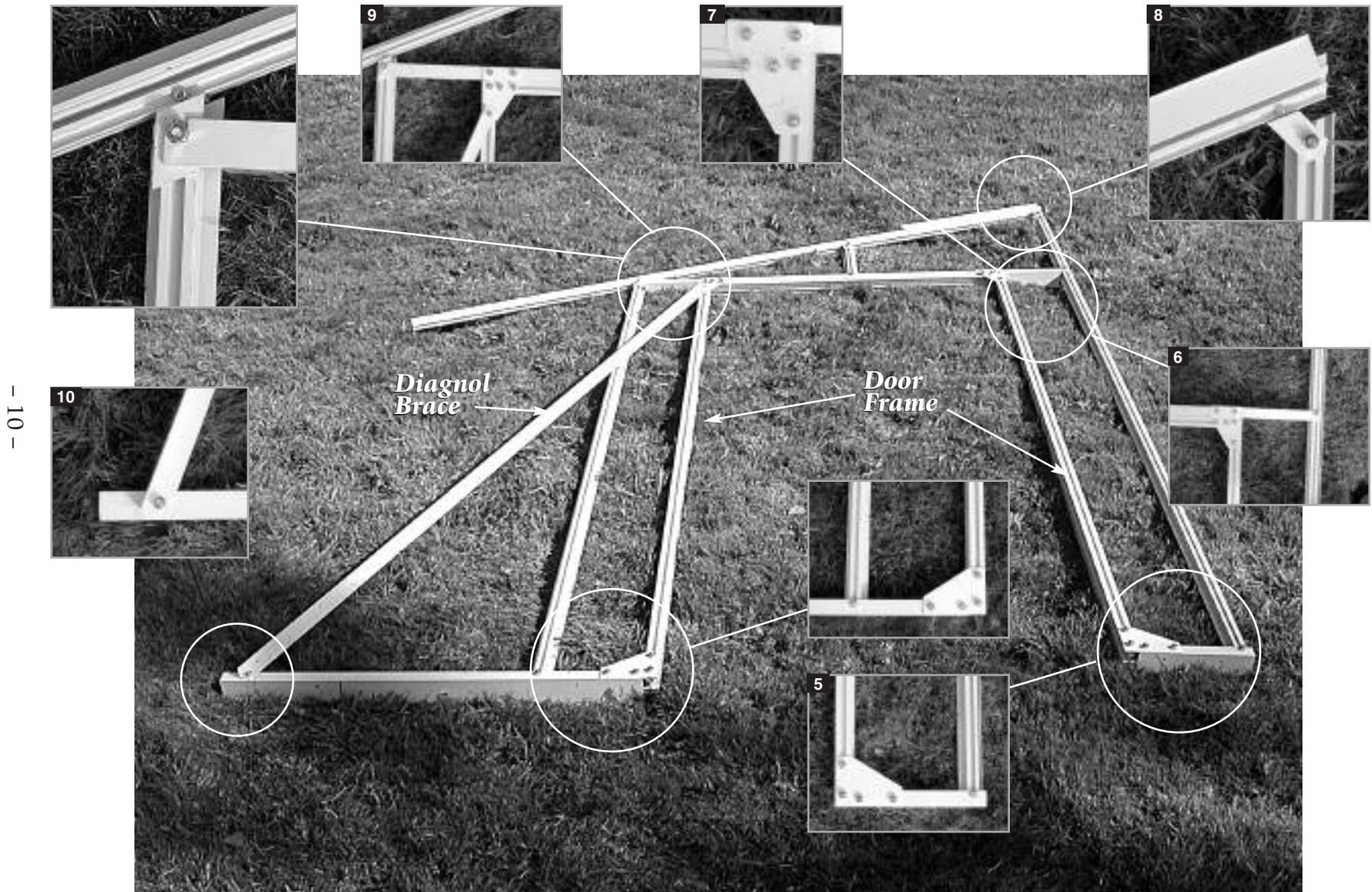

CROSS COUNTRY SERIES STRAIGHT LEAN TO MODEL • GREENHOUSE INSTRUCTIONS

C. SIDEWALL ASSEMBLY

Sidewall includes gutters, bars and sidewall poly bars.

1. Lay out the sidewall with the gutter at the top, the base at the bottom, and the sidewall poly bars with the bolt track facing up. *(See the sidewall drawing assembly procedure.)*
2. One Poly End Bar will have an angle fastened to it. This bar is bolted at the end where the back gable will be attached.
3. Slide the bolts in the Side Bars *(top and bottom)*.
4. Attach the Side Bars to the gutter first *(this end has the angle cut on it)*.
5. Attach the Side Bars to the base / sill.
5. You are now ready to assemble the greenhouse.

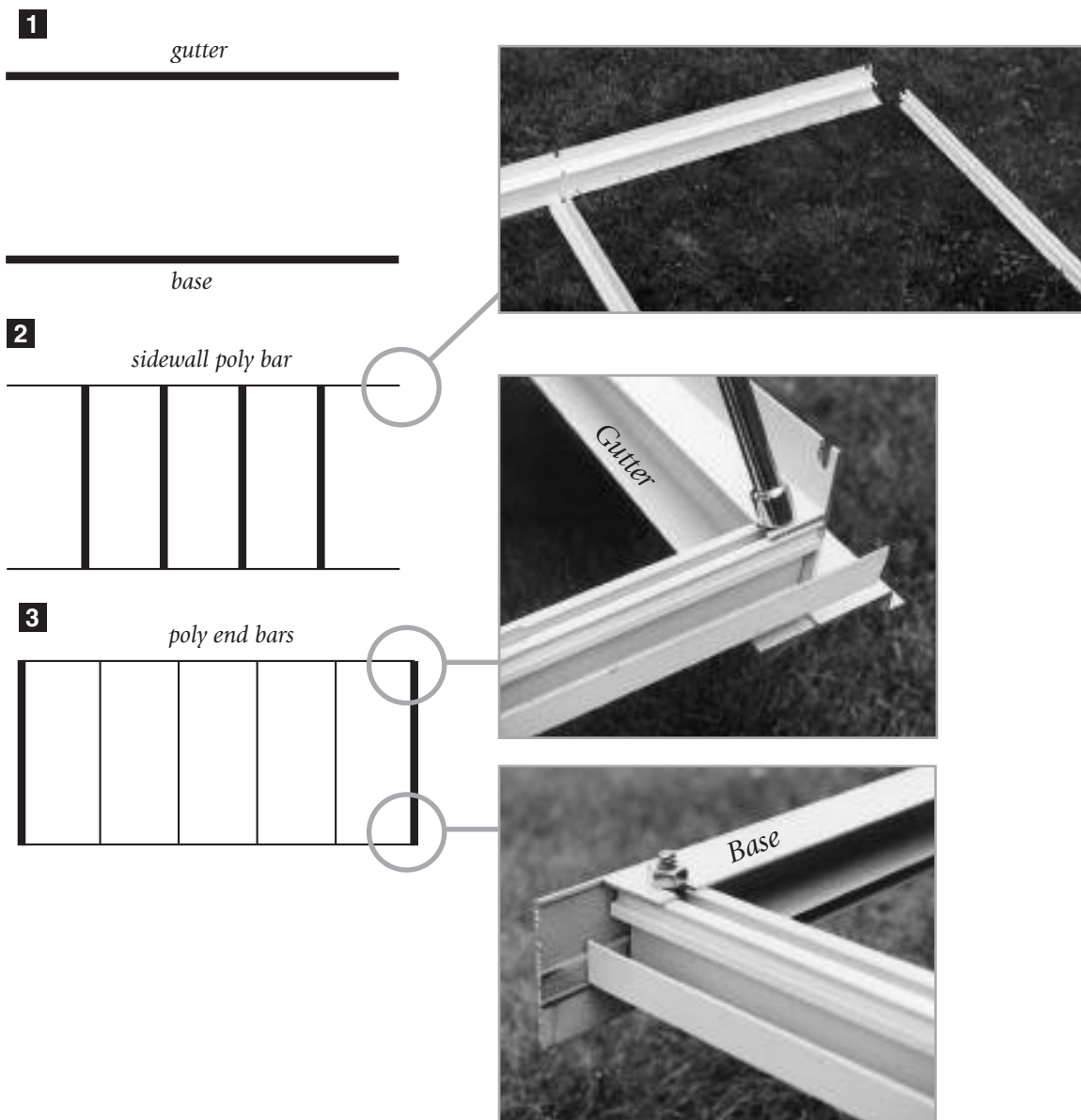

C. TAPING POLY BARS WITH FOAM

Tape all the aluminum poly bars with a 1/8" foam gasket. Tape the poly end bars on one side only. Tape all the other poly bars on both sides. Take a roll and, starting at one end, press on the bar. *Make sure that the aluminum is dry.* (You should move all the pieces into a shed or undercover if it is raining.) Slowly roll down the tape toward the outer edge and press it down at the same time. (See Details #14A & B.) Be careful because sometimes the edge of the paper is quite sharp. Do not remove the paper until later. Do not tape where the poly bar is notched out. (See Detail #15.)

NOTES: Taping can also be done either before (as shown in pictures to the right) or after the greenhouse is assembled.

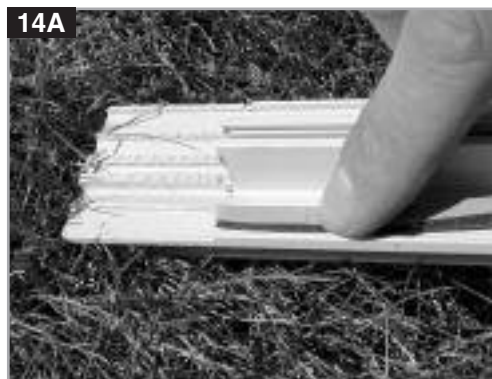
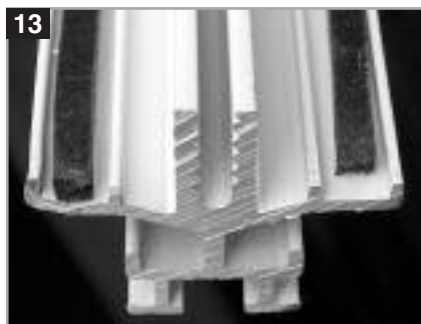

*Do NOT put foam tape along the End Bars.
The polycarbonate slides under the lip and needs to be sealed
when the greenhouse is finished*



Aluminum Frame Installation

Check that the foundation is level and square (*See page 14* **1**). If your foundation is larger than the greenhouse, mark a line on it with a pencil or with a chalk line. Take a caulking gun and put in a tube of caulking. Cut 1/4" off the top at a 25-degree angle. Then put a bead of caulking on your foundation approximately 1" in from the outside of the foundation or the marked line. **DO NOT CAULK THE DOOR OPENING.** Measure your door opening in the front.

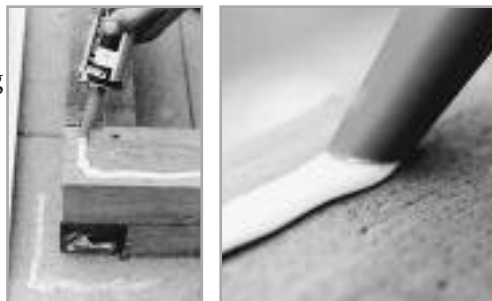

1. SIDE

Stand up side wall flush with your base on the line you have marked out. Push down on it so that the caulking squeezes out. You can put some screws in the base to hold it or lean it against ladder till you do the front end. (*See Step 1 Detail, page 14.*)

2. FRONT GABLE END

Stand up the door end, flush with your base or marked line. Slide up one bolt in the bottom of roof poly end bar. Take the end bar and push it into the gutter. The back of the roof poly bar lines up with the first slot in the gutter. Slide the bolt down and fasten it. When you are lined up and in the right place, screw down the front base/sill using the screw holes that are already there. Then put one screw in the side base to hold it in place. When you have fastened down the front, it should stand by itself. (If it is windy, you will need another person to hold up the front, or you can use a stepladder so that the front can lean against it.) Next plumb the glass bar against the wall and put in 1" screw for now. (**NOTE:** *after the greenhouse frame is up, double check for square and plumb. Seal behind the poly bar and the ridge, then put in all the screws.*) (*See Step 2 Detail, page 14.*)

3. BACK GABLE END

Follow the same procedure for the back gable end as you did for the front. When you have bolted it to the gutter and it lines up flush with your base/sill or marked line, then you can proceed. Fasten the base/sill down to your foundation with the screws that are provided. When fastening the side/base sill to the foundation, be sure that the base is straight.

(*See Step 3 Detail, page 14.*)

4. RIDGE

Before you slide in the ridge, put one bolt in the top of each end bar. Take the ridge (*one person at each end*) and slide it between the end bars on the top. You will notice the punched-out slots in the bottom flange of the ridge. The slots on the end line up with the bottom side of the poly end bar. Now slide in the ridge and slide the bolt into the ridge slot. Make sure that the poly end bar is tight against the ridge – use a 7/16 flat wrench (*at this time you can temporarily fasten the ridge to keep it from moving around*).

4A. SEE APPENDIX A FOR TRUSS ASSEMBLY INSTALLATION FOR GREENHOUSES LONGER THAN 16 FEET.

5. ROOF POLY BAR WITH SLIDERS (1, 2, 3 etc.)

Each Poly Bar (with a vent frame slider) is marked with a number (1, 2, 3 . . .) to correspond with the number on the ridge. Slide the bolt into the top of the Poly Bar and line it up with the slot in the ridge. Move up the bolt and fasten it. Do the same for the bottom of the roof poly bar. Slide in the bolt, and bolt it to the gutter. Do this for all the Poly Bars with sliders and numbers. The top end of the bar should be tight against the ridge. (*See Step 5 Detail, page 16.*)

6. VENTFRAME ANGLE

The ventframe angle is 50" long with the ends cut out to fit between the two Poly Bars with sliders. *The ventframe is the same shape as your base/sill.* Put the head of the bolt into the punch out in the back of the poly bar (24" from the top), slide the bolt up and fasten it to the ventframe on the bar. Make sure that the angle flanges are facing toward the sidewall (down) and that it is pushed up against the side sliders (already on the Poly Bar). Do this for all of them.

(See Step 6 Detail, page 17.)

7. ROOF POLY BARS

Bolt on all the remaining Poly Bars. Make sure that the top is tight against the ridge.

(See Step 7 Detail, page 18.)

8. ROOF PURLIN (CHANNEL)

When installing the roof purlin, mark it out by measuring from the ridge. The roof purlin should be located approximately the center between the ridge and the gutter. Always face the open end of the purlin up towards the ridge so that it can be used for hanging baskets. Every Poly Bar has notches punched out so that the head of the bolts can be inserted and can slide up or down on the bar.

(See Step 9 Detail, page 20.)

9. TAPE ALL POLY BARS

Complete all taping with the 1/8" foam tape if it was not done before.

(See photographs, page 12.)

10. FASTENING / SEALING THE GREENHOUSE TO THE WALL

Before you seal behind the ridge and end poly bars, square your greenhouse using the 3/4/5 method (see sketch). Sometimes the foundation is level but your wall is not plumb. You may have to decide to pull the greenhouse away from the wall or make your foundation off-level. When your greenhouse is squared up, mark the edge of the ridge on your wall and pull your greenhouse away from the wall and seal behind it. Push the greenhouse back to the wall and fasten it with screws. **NOTE:** Sealing can also be done after greenhouse is finished and before the vents are installed.

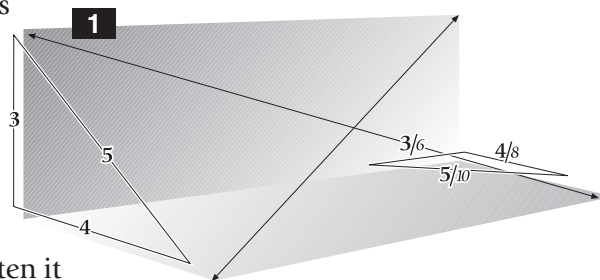

11. SIDE VENTS, INTAKE SHUTTER AND EXHAUST FANS INSTALLATION (IF NECESSARY) SEE APPENDIXES B THRU E. THEN RETURN TO THE NEXT PAGE AND CONTINUE

Assembly Outline

Step 1: Side

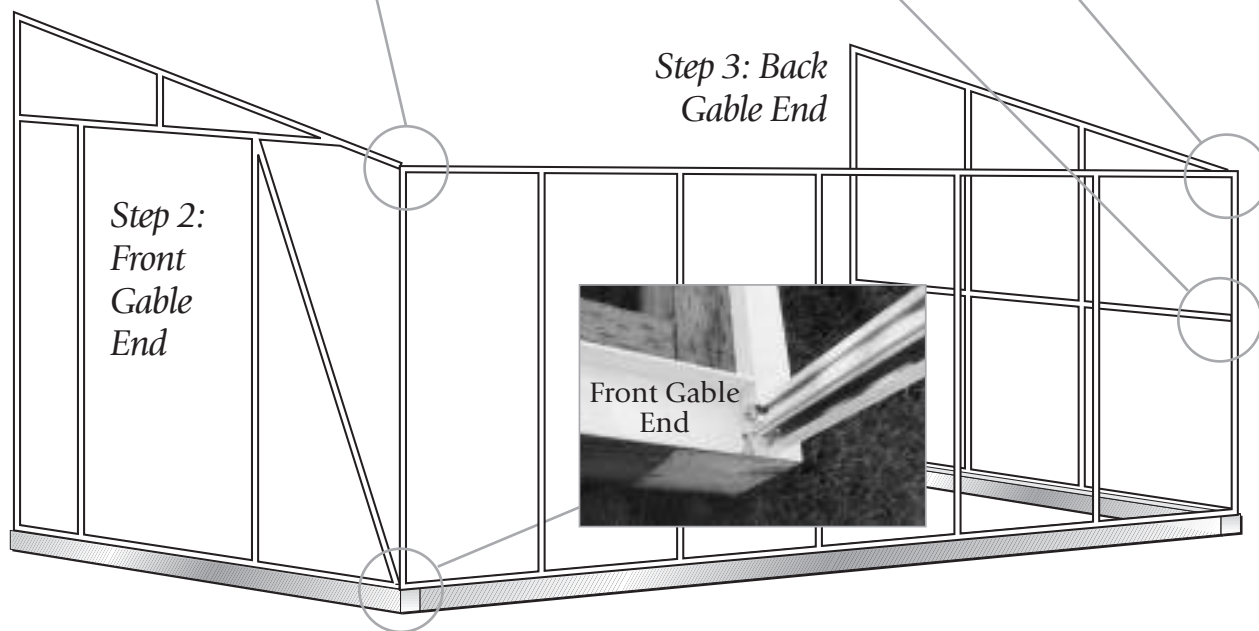
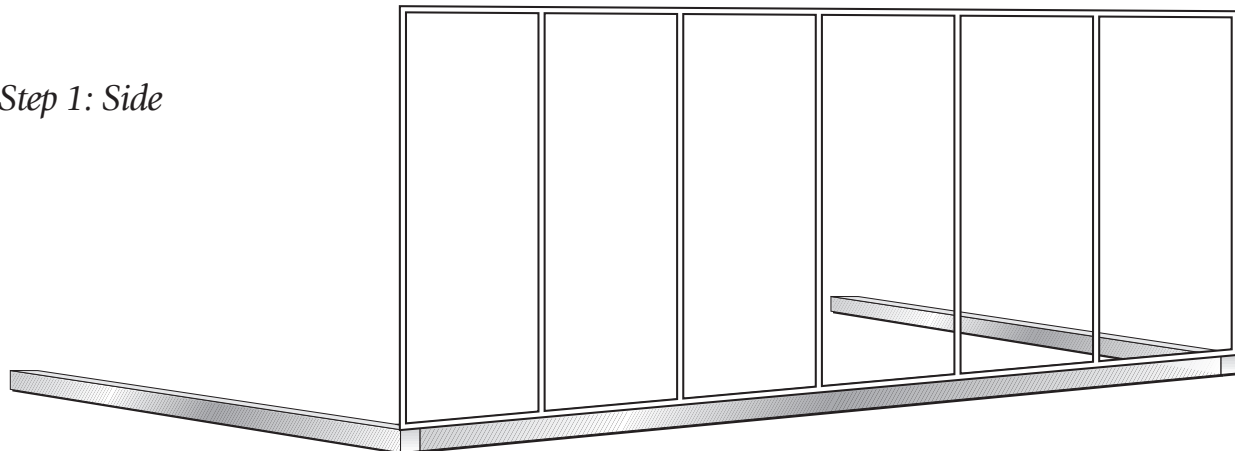

Step 4: Ridge

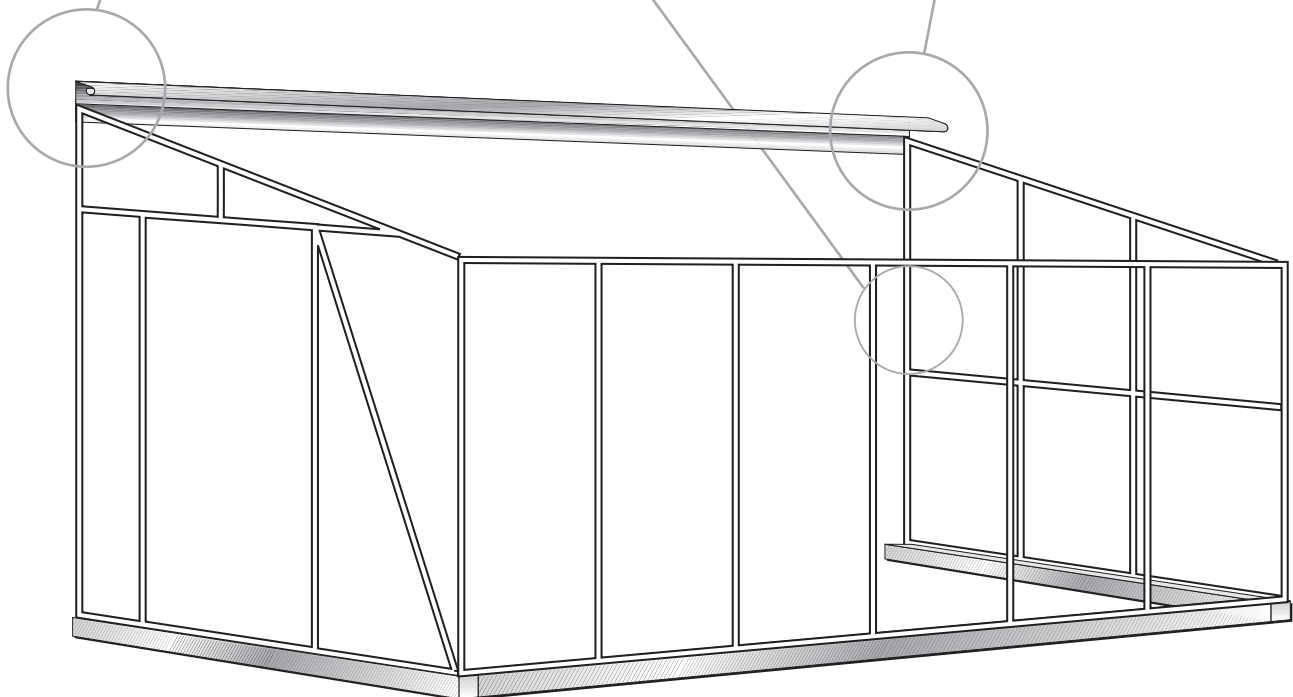

Step 5: Poly Bar with Vent Frame Sliders

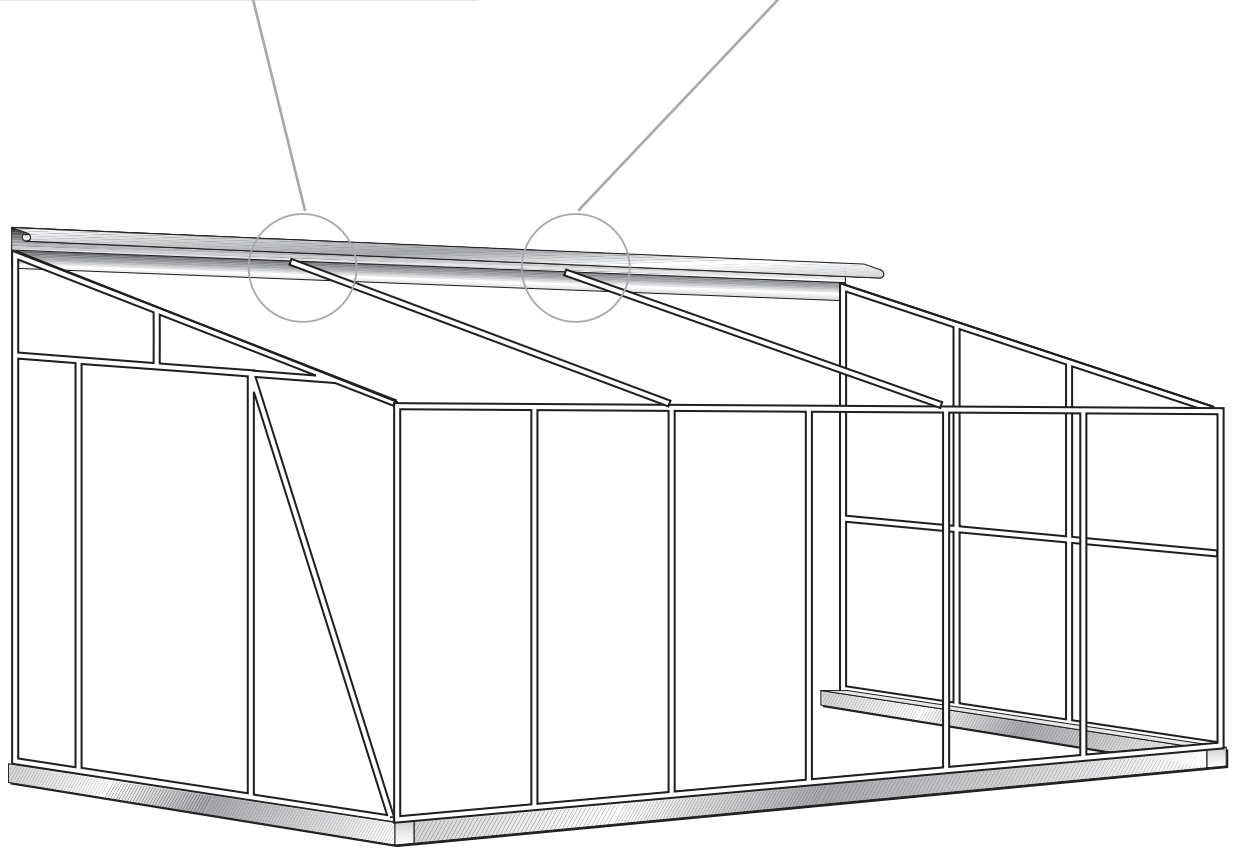
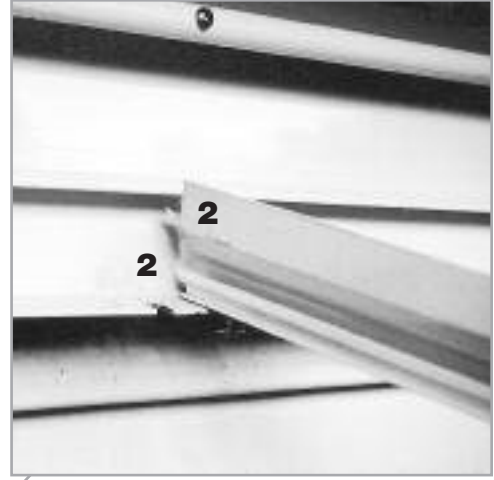

Step 6: Vent Frame Bottom

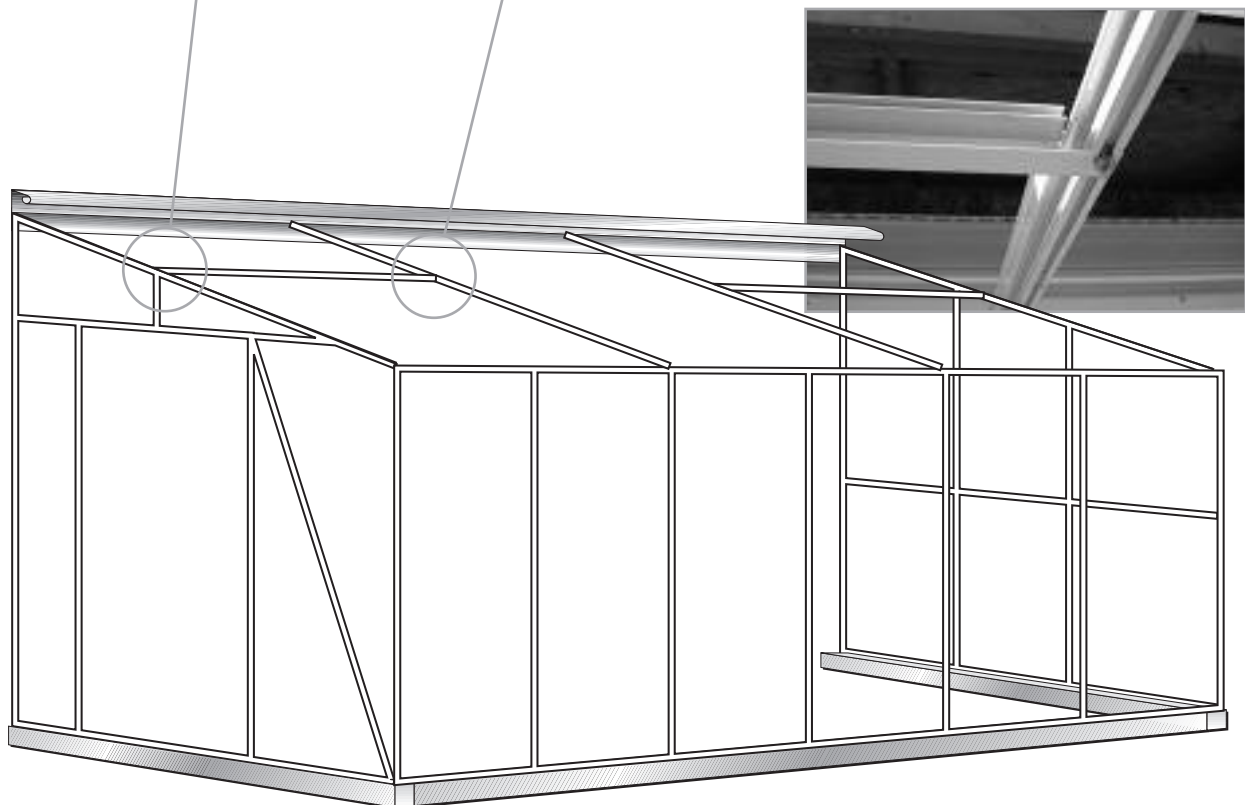
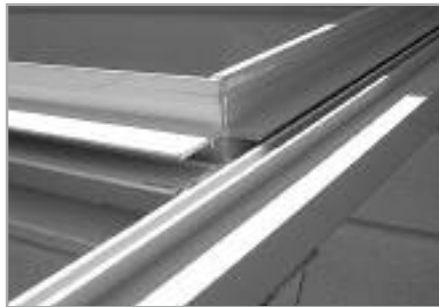

Step 7: Install All Remaining Poly Bars

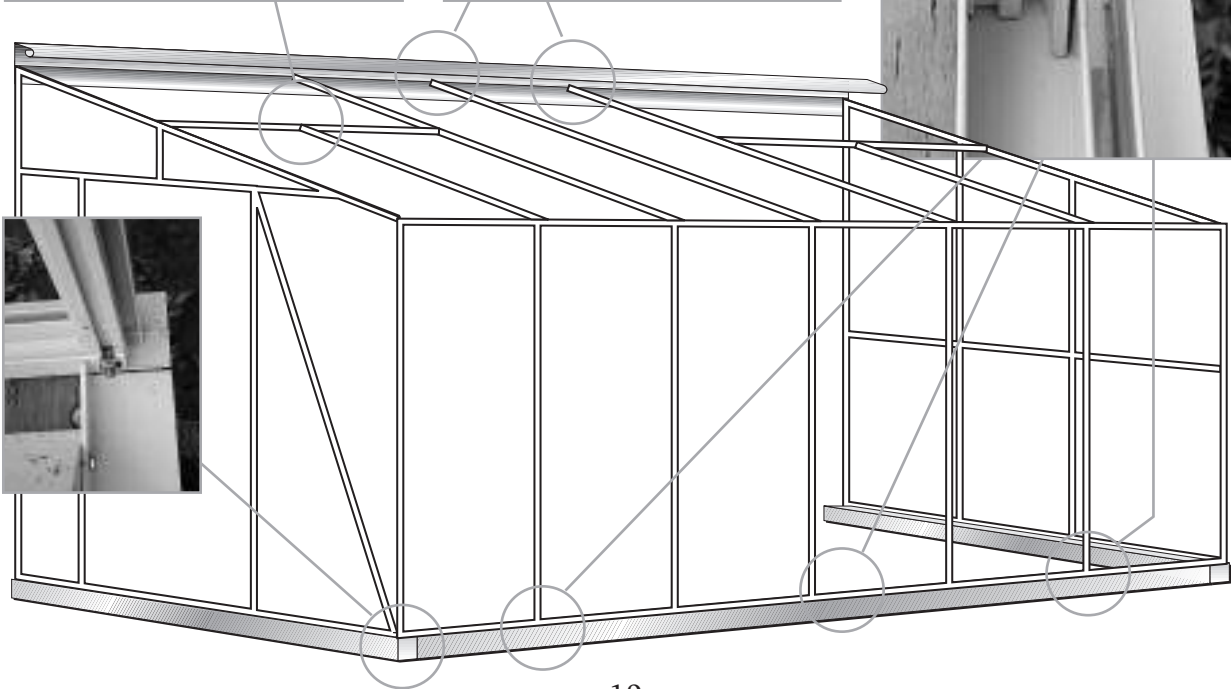

Step 8: Roof Purlin



3" Purlin on larger greenhouses

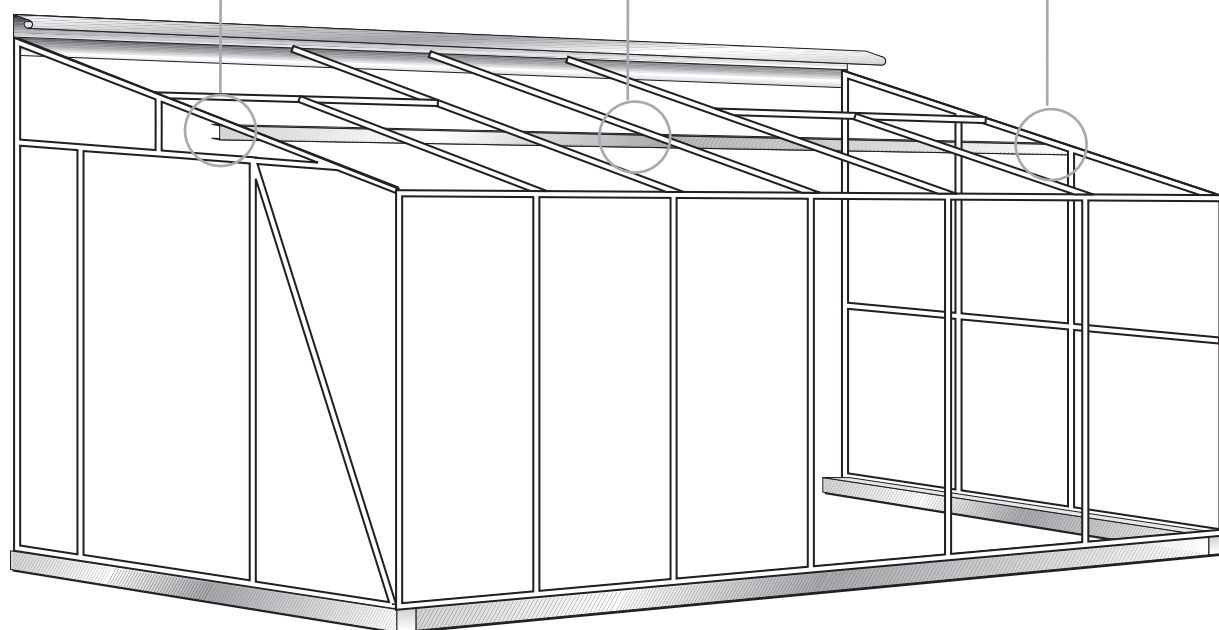

Polycarbonate Panels & Cap Installation

GENERAL INFORMATION ABOUT HANDLING POLYCARBONATE

All polycarbonate sheets are covered with a thin sheet of plastic on both sides to prevent the sheets from becoming dirty and scratching during handling. One side is a clear plastic while the other side is blue or some other colour, depending on the manufacturer. This latter side should be installed so that it faces out. *(The sheet is marked to indicate which side should face out.)*

Before you begin installing, lay out the sheets lengthwise so that it is easier to take the one you want to install. Do the same with the capping.

Remove all the paper on the foam strip on the greenhouse before you begin installing the panels.

If the weather is warm and sunny, the foam strips will be sticky. Take a trigger spray bottle and fill it with soap and water. Just before you install the panels, spray the foam lightly so that the panels can be moved around.

(Do not store polycarbonate bundles outside in the sun. Instead, store them in a cool dark place, such as a garage, until you are ready to use them.)



12. ROOF

Take the roof polycarbonate sheets and peel off the plastic. Mark the outside of each panel in the corner. Put on aluminum "H" with the flat side out **1**. Take the first panel and slide the top of the panel into a ridge track or Vent Frame track **2**. Lower the panel onto the poly bar and drop the "H" into the gutter **3**. If the roof is off-square, push or pull the gutter to the front or back to make the roof square. Take a Poly Cap *(check for length)* and lay it on the Roof Poly Bar and fasten it with a

#8 x 1/2" screw **4**. Continue this way until the whole roof is done.

NOTE: *If your greenhouse is small you can lay in all the roof panels first and put the caps on later.*

NOTE: *Picture #3 shows foam in the gutter. We recommend that you **do not foam the gutter**, the aluminum will lay flatter. You will have to seal it with silicone when all the roof is done.*

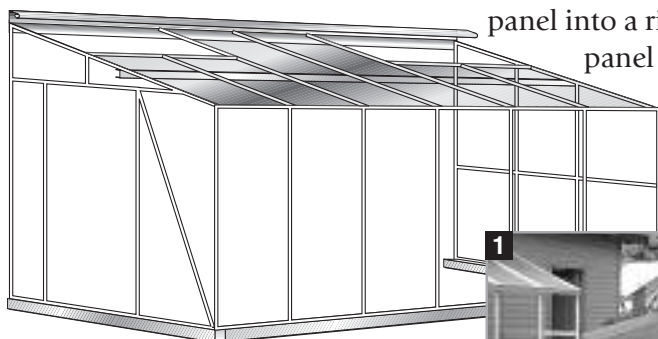

13. BACK / FRONT GABLE ENDS

Find the bundle marked "Front or Back." Peel the plastic off the panels. You can start against the wall or move towards the low side or visa versa. If you have a problem with the corner panels going in (because you have to twist the panel), remove the poly end bar - install the panel and re-install the poly end bar.

Fasten the caps (*same way as the roof*) with #8 x 1/2" screws.

NOTE: *You need to put the aluminum "H" on the top and bottom of the panels beside the door – see pictures **1**, **2** and **3**.*

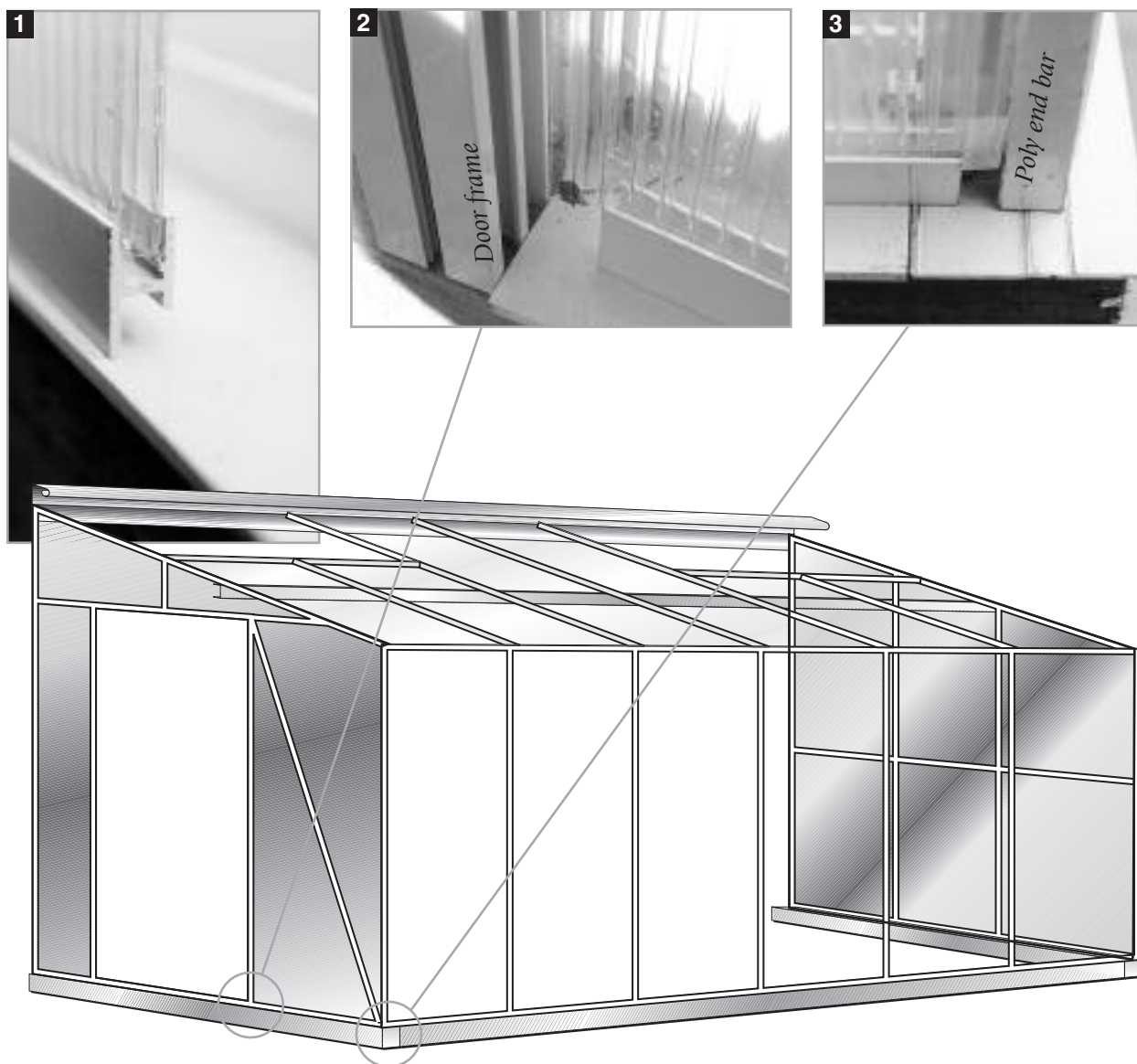

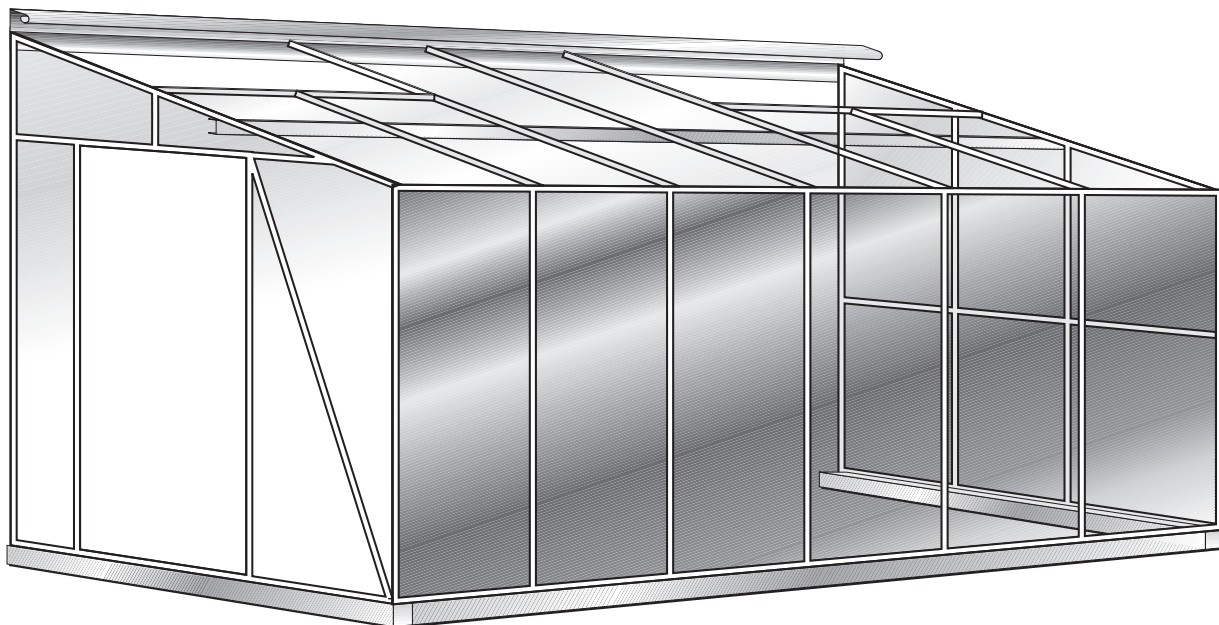

14. SIDEWALLS

Once the polycarbonate is installed in the roof and gable ends, proceed to the sidewalls.

Spray the foam if it is sticky. Stand the sheet up into the bottom track of the side base/sill. Put "H" on top of the panel (*see sketch to the right*). Bend the panel and slide the top of the panel behind the gutter edge. Push the panel against the foam and then apply the caps in the same manner as you did the roof and gable ends.

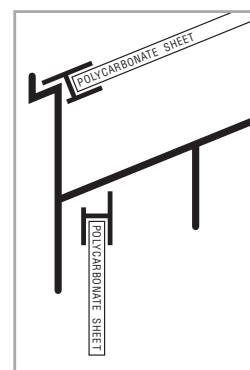

15. SEALING THE GREENHOUSE

When all the polycarbonate sheets are installed, take a tube of clear silicone sealant and seal all the panels that fit into the aluminum tracks on the top, the bottom, the inside and the outside. In this way, you can keep out most of the moisture from the end of the panels. If this sealing process is not done, water will sit in the bottom, fill the inside of the panels and grow algae.

1. Unscrew the plastic nozzle on the tube of silicone sealant.

2. Cut the top of the tube.

3. Screw on the plastic nozzle again.

4. Cut approximately 1/8" off the end of the plastic nozzle at a 30-degree angle.

5. Put the tube into the caulking gun. When using the gun, squeeze the handle slowly.



6. Wherever the polycarbonate sheets are sitting in a track or aluminum "H", seal the edge, including the end poly bars. Also seal the inside of the sidewalls because greenhouse humidity runs along the walls and into the bottom track.

7. Seal the vents before you slide them into place. Seal the places where the panels fit into the door frame bar and the "H" under the above door angle.



Inside view



Outside View

CAULKING

- Seal the door frame bar where the base/sill meets the door frame.
- Seal the inside of the base/sill along the perimeter of the foundation.



Roof

16. DOOR INSTALLATION

(Refer to the drawing.) Take the door and set it inside the door frame. Lift it up as high as possible on the hinge side and put the screws through the existing holes in the door frame. Now the door will hang by itself.

Remove the black clip from the "Z" bar and put one screw into the door frame to hold the "Z" bar. Open the door, take off the clips and put back the screws. Close the door and check that it is square. If the frame and the door are square, then fasten the "Z" bar to the frame. If not, move the "Z" bar up or down to square it. If this is not enough, loosen the bolts in the top plates and move the frame to make it square. When it is in place, tighten all the bolts.

Next install the door handle (see the instructions inside the box). To install the door catch angle, slide in two bolts into the back of the door frame. Bolt on a small angle (provided with the door handle). Face the angle towards the door, line it up with the center of the door handle, and then tighten the two bolts (see picture to the right). Take the door catch out of the door handle box and screw it on. Close the door and adjust the door sweep at the bottom of the door to eliminate potential gaps.

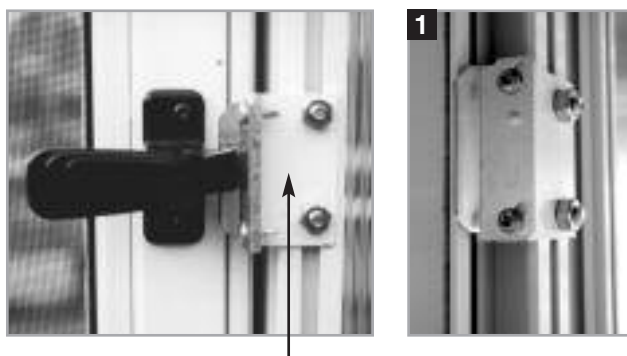

Door Catch Angle

NOTE: There are two types of manufactured doors. The door catch angle on the white door may have to be turned the opposite way as shown on picture **1**.

Run a bead of silicone under the angle above the door and against the door frame. Also silicone the "H" on the polycarbonate beside the door to ensure an airtight seal.

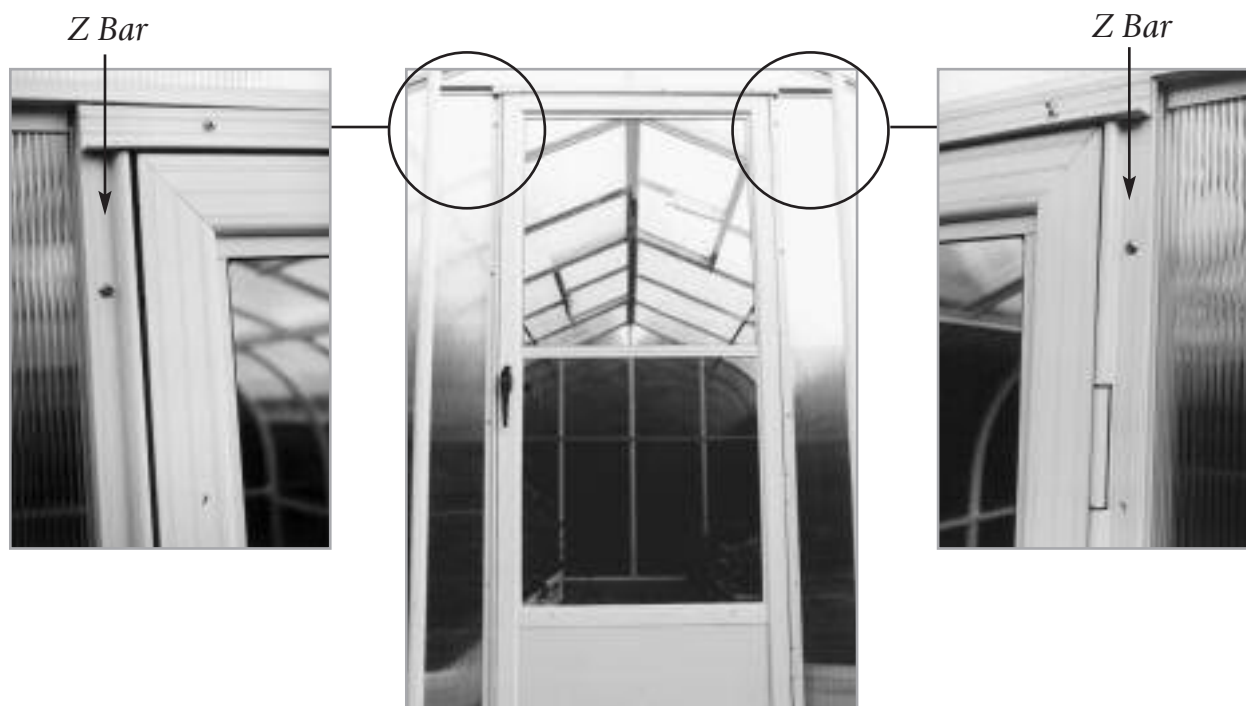

Door Installation

- 26 -

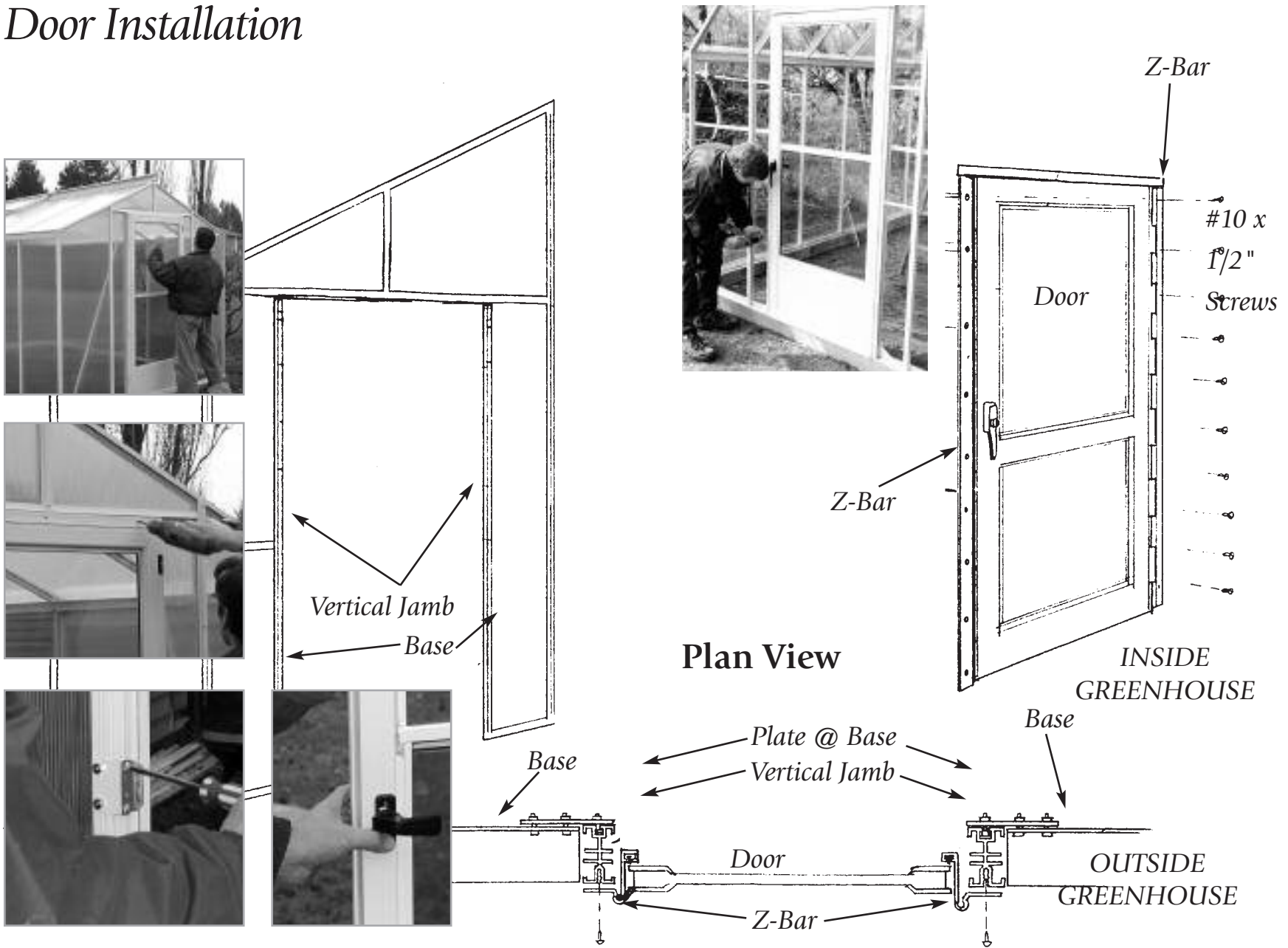

CROSS COUNTRY SERIES STRAIGHT LEAN TO MODEL • GREENHOUSE INSTRUCTIONS

17. VENT ASSEMBLY (SEE DRAWING & PICTURES PAGES 27 – 30)

1. Lay down the gutter with the punches facing up towards you.
2. Poly bars with sliders on are for the end. Lay them down with the bolt slot facing up.
3. Hinge with punches facing up towards you.
4. Slide the bolts into both ends of the end bar. Take the gutter and line up the bolt with the 1st punch, slide the bolt down and tighten it. Do the same with the hinge, other side and center bar. Make sure that the poly bars are tightly fitted to the gutter and hinge after vent assembled.
5. Turn it over and square it up.
6. Put 1/8" foam on the poly bars.
7. Take polycarbonate panel, remove the film (*clear inside*) and slide it into the hinge track. Before you do this; remove the paper and lightly spray the foam so that it doesn't stick. Lay it on the foam and slide it into the hinge (top) section and then down into the gutter track. Do the same with the next piece.
8. Take the caps and lay them on the bars, center them, fasten with 1/2" screws.
9. Take the silicone gun and seal where the sheets slide into the track. *Inside and out.*

18. VENT INSTALLATION

Take the vent and slide it in the end of the ridge. You will have to remove a rectangular screw in the ridge. Then push it into place and put the screw back in. Now attach manual opener (*picture A*).



Vent Assembly - Exploded View

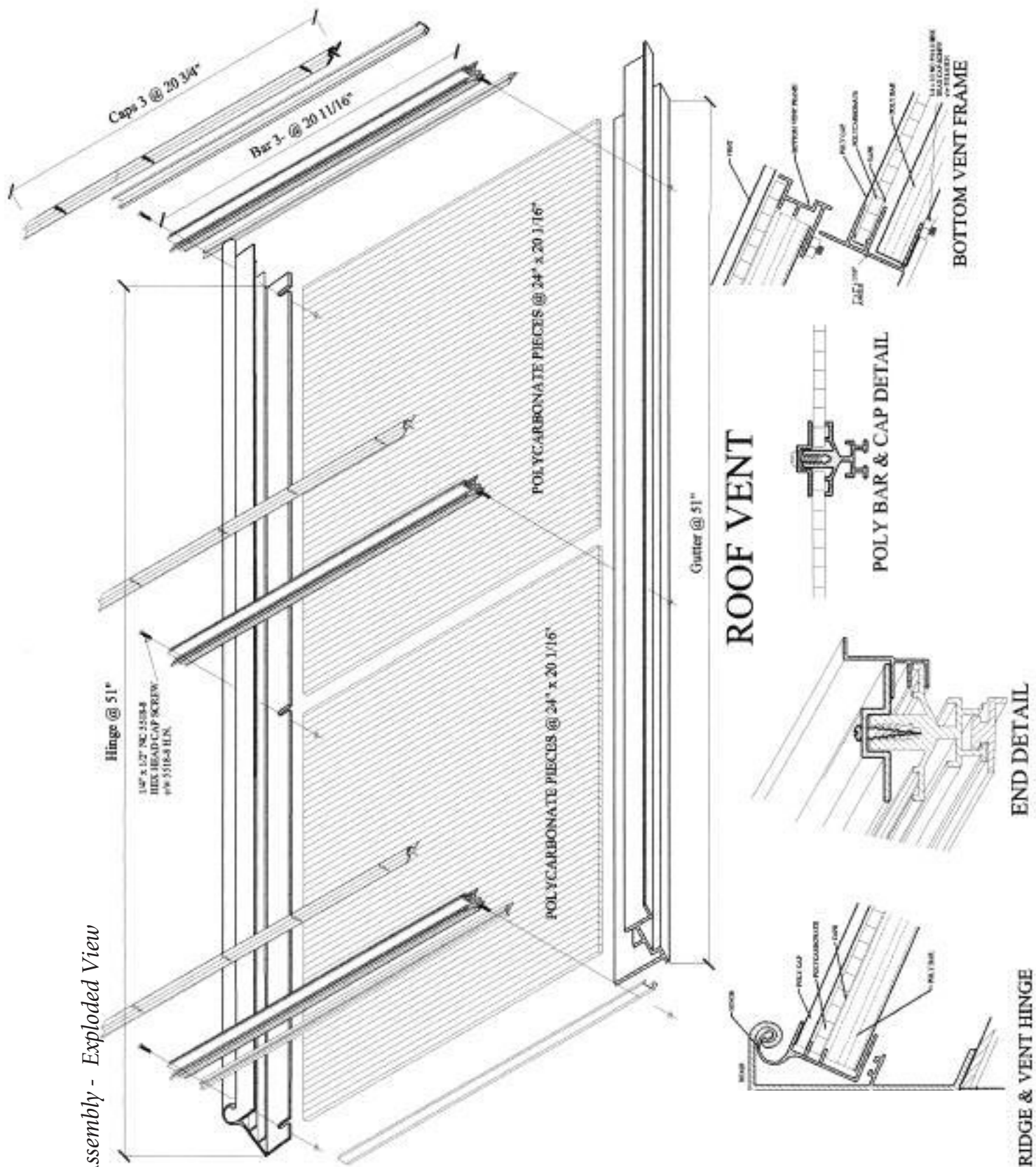

Greenhouse Roof Vent Details



Appendix A – Truss

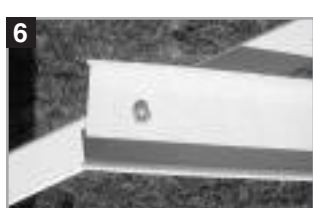

1. TRUSS ASSEMBLY

(This section is to be used only for greenhouses that are over 14' long.)

Trusses are usually installed after the sides, base, front, back and ridge are bolted together. Make sure that the greenhouse is temporarily braced (*see 4A on Aluminum Frame Assembly*).

- A. Lay the truss piece in the shape of an end wall.
- B. Slide the center pieces into the top of the truss and bolt them together. **1**, **2** and **3** (*lean to models do not have a center piece – see next page*).
- C. Slide the truss feet into the bottom of the truss and bolt them together. **4** and **5**.
- D. Bolt on the cross brace (*if required*) **6**.

2. TRUSS ASSEMBLY & INSTALLATION (IF REQUIRED)

The next step takes two people, one on each side. Carry the truss to the center of the greenhouse and put the feet on your foundation between the side base/sill **7**. Lift the top of the truss towards the ridge and bolt it on **8**. Use the notch on either side of the center. (*For lean to installations line up the top of the truss 1⁵/₁₆" off-centre of roof glazing bar and temporarily fasten with a screw to the wall. This should be permanently lagged to the wall after greenhouse is square and the purlin has no sags at the truss. The gap between the underside of the bar and top of the truss should be 3."*)

Remove the truss bracket from the truss. (*It may also be in a plastic bag.*) Unbolt the bar from the base. Slide the truss bracket into the bottom of the glass bar (*long bar*) **9** & **10** and slide it to the place where there is a 9/64" hole drilled into the truss. Fasten it with a screw. If the hole does not line up, you may have to drill a new hole in the truss bracket **11**. Do this after all the glass bars have been bolted together. To fasten the truss to the foundation, use 1/4" x 2" leg bolts.



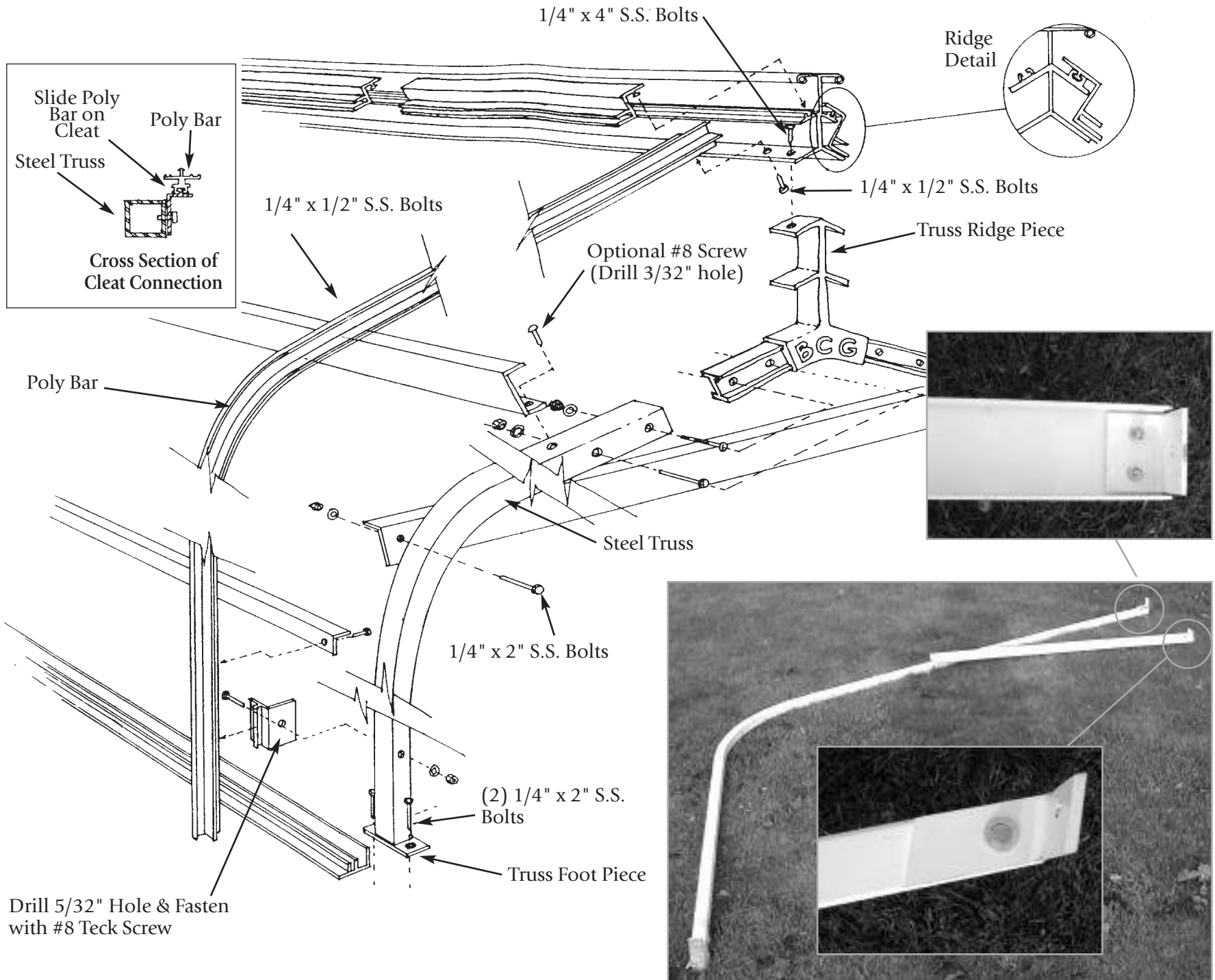

Appendix B – Vent Opener

INSTALLING THE BAYLISS AUTOMATIC VENT OPENERS

Detailed instructions are included in the box with the control (there are a few extra parts).

Use #8 stainless steel screws to fasten the Bayliss and the vent sill ① and the vent ②. All holes are already drilled.

After the Bayliss is fastened in place, install the threaded adjuster into the swivel block. This is made easier by lifting the vent with one hand until the piston rod only projects 1/2" through the swivel block.

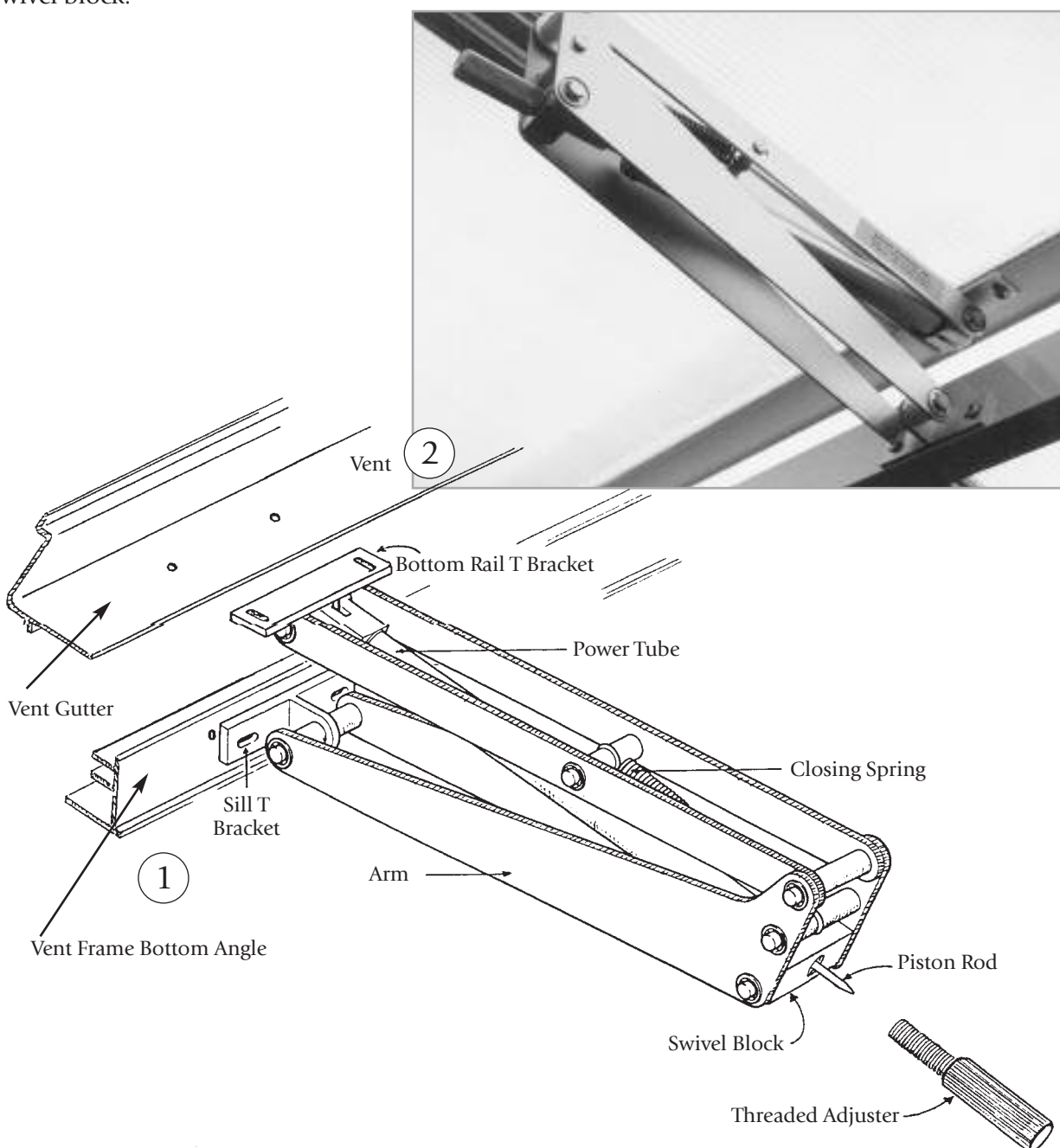

Appendix C – Motorized Intake Shutter

INTAKE SHUTTER ASSEMBLY

Inside View

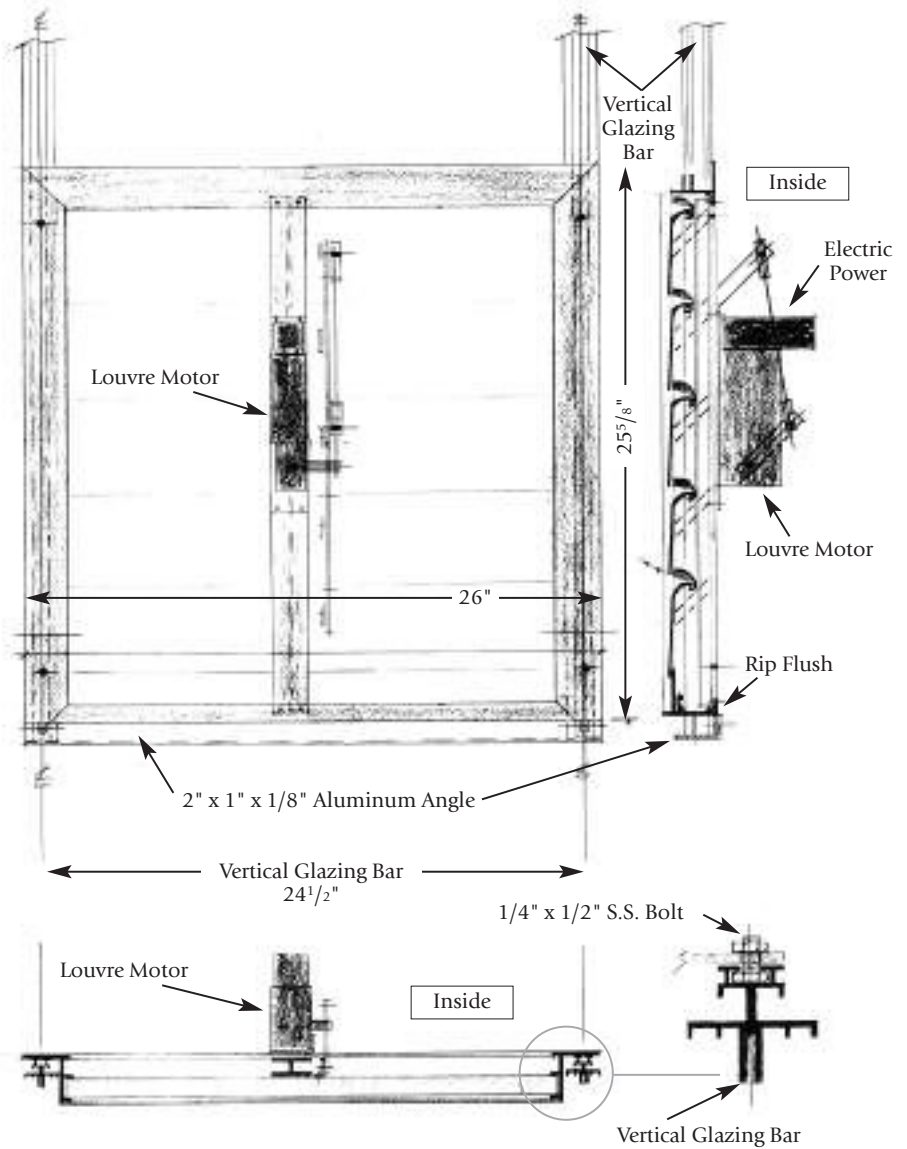

Outside View



Appendix D – Exhaust Fans

INTAKE SHUTTER ASSEMBLY

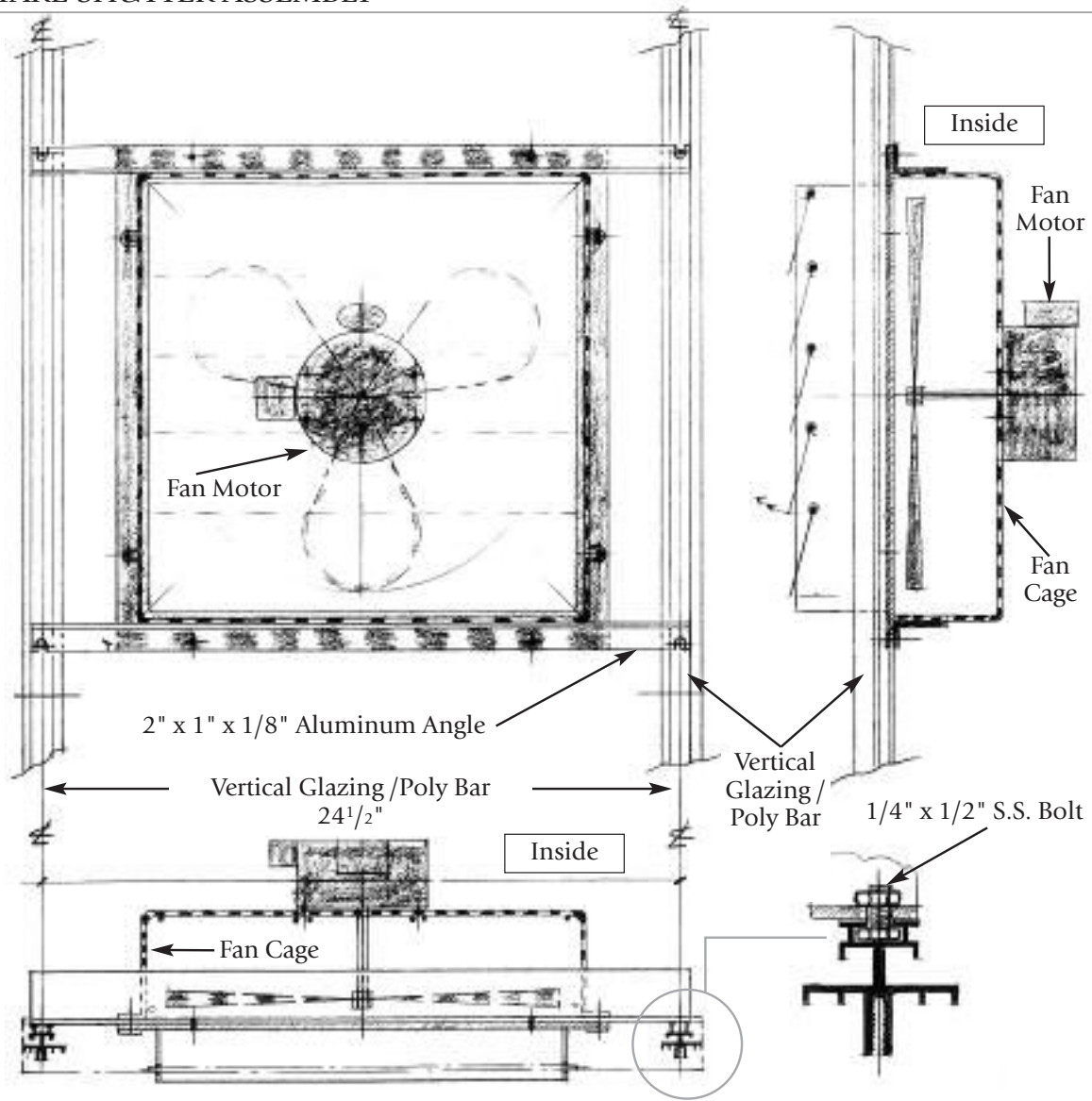

Appendix E – Glass Louvre

GLASS OR POLYCARBONATE GLASS LOUVRE ASSEMBLY



Appendix F – Side Vent

GLASS OR POLYCARBONATE SIDE VENT ASSEMBLY

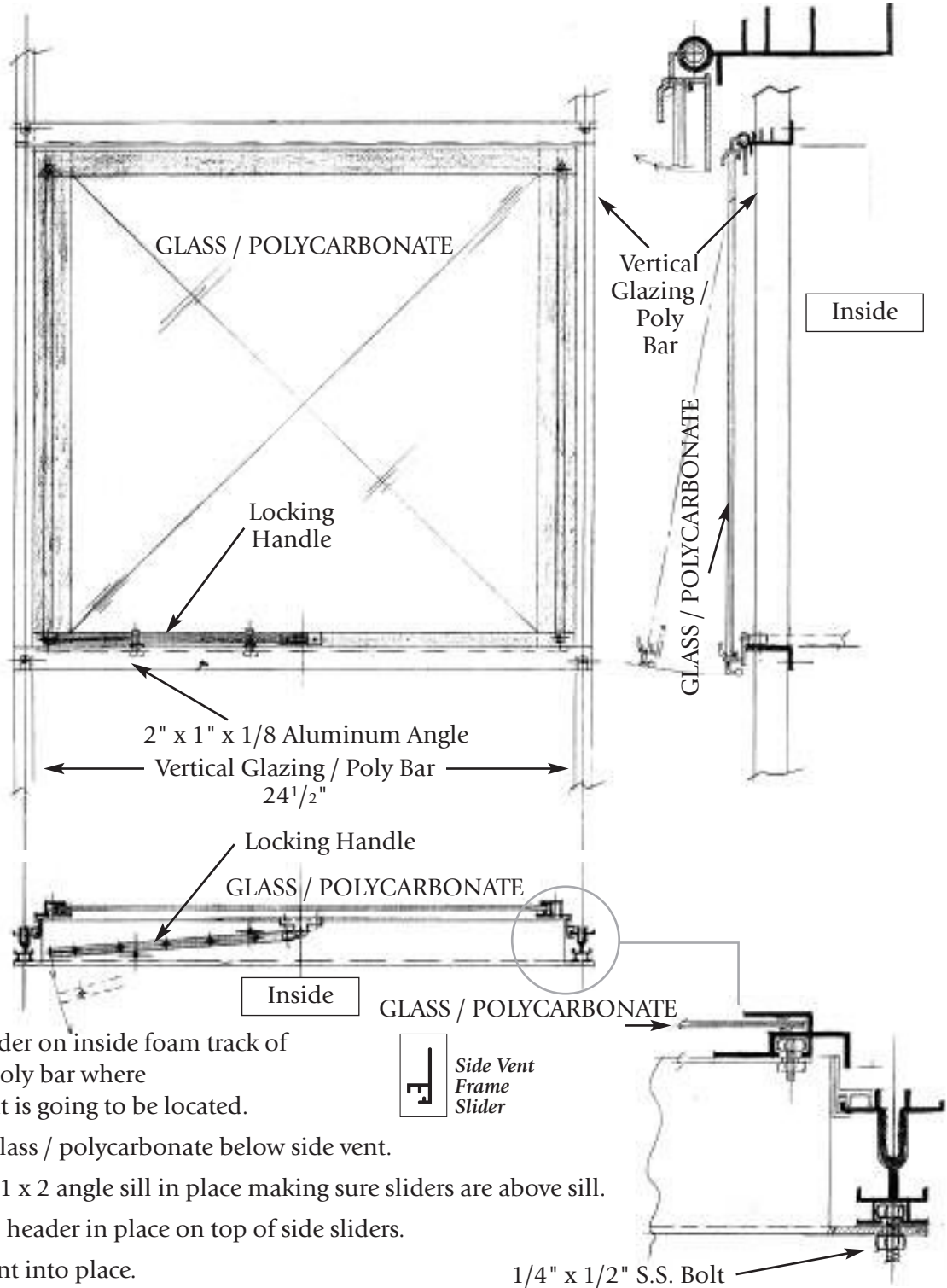

1. Slide slider on inside foam track of glass / poly bar where side vent is going to be located.
2. Install glass / polycarbonate below side vent.
3. Bolt on 1 x 2 angle sill in place making sure sliders are above sill.
4. Bolt top header in place on top of side sliders.
5. Slide vent into place.
6. Install automatic or manual opener.



1/4" x 1/2" S.S. Bolt

Appendix F – Side Vent CONTINUED





At this point, stand back and enjoy your workmanship.

*Your Cross Country Straight Lean To Greenhouse
should now be closed in and ready for use.*

Congratulations!