Cross Country Series Curved Model

GREENHOUSE INSTRUCTIONS



Manufactured for:



Contents

Foreword	2
User Notes	2
List of Drawings	3
Cross Country Component List	4
Foundations	5
Assembly of Aluminum Frame	
A. Front Gable End Assembly With Door	6
B. Back Gable End Assembly	9
C. Taping Polybars With Foam	11
Aluminum Frame Installation	
1. Side Base / Sill	12
2. Front Gable End	12
3. Back Gable End	12
4. Ridge	12
4a. Truss Assembly Installation (if necessary)	See Appendix A
5. Polybars With Sliders (#1 or #2)	12
6. Vent Frame Angle	13
7. Polybars	13
8. Side Brace (Angle)	13
9. Roof Purlin (Channel)	13
10. Center Bars Front And Back	13
11. Tape All Polybars	13
11a. Automatic Ventopener, Side Vents, Intake Shutters & Exhaust Fan Installation (if necessary)	See Appendices B-E
Polycarbonate Panels and Cap Installation	
General Information About Handling Polycarbonate	21
12. Side Walls	21
13. Door End Wall	24
14. Back End Wall	24
15. Sealing The Greenhouse	24
Door And Vent Installation	
16. Door Installation	26
17. Vent Assembly	28
18. Vent Installation	28
Appendices: Optional Installations	
Truss	Appendix A
Vent Opener	Appendix B
Intake Shutter	Appendix C
Exhaust Fan	Appendix D
Side Vent	Appendix E
Class Louvre	Appendix F
Diagonal Brace	Appendix G
Cedar Bench	Appendix H
Greenhouse Bench	Appendix I
Roof Vent Screen	Appendix J
Side Vent Screen	Appendix K
Wire Shelving	Appendix L

Foreword

Your Cross Country greenhouse is designed and constructed to the highest engineering standards and provides structural strength and maintenance-free service for year-round gardening pleasure.

The Cross Country greenhouse must be built upon a firm, level surface. The greenhouse foundation or sill can be made from pre-treated timbers, concrete or bricks. Whatever your choice of material, the base must be square and level.

When selecting a site for your greenhouse, keep in mind that a flat, level site is essential so that the greenhouse can be easily installed and the complete structure is stable and secure. If possible, choose a site with proper water drainage.

Locating the greenhouse in a north-south position is most suitable for raising summer and autumn crops since the sun's rays will be on the greenhouse from daybreak until sunset. An east-west position is ideal for early spring and winter crops since the winter months, with shorter daylight hours, still allow six hours of light exposure to the greenhouse.

Try to locate your greenhouse for easy access, especially to the necessary power and water that is required for greenhouse gardening.

Please watch the enclosed video and follow the steps in this manual for your greenhouse installation. *Remember, if all else fails, read the instructions.*

User Notes

The Cross Country greenhouse structure has been designed to withstand extreme weather conditions such as high winds and accumulated snowfall. Hanging baskets and sidewall shelving can also be attached to its sturdy frame. The greenhouse design also makes it possible to add extra sections at a later date.

Sealing the polycarbonate sheets to the aluminum "H" and base is optional, however we highly recommend it. Eliminating any water from entering the inside of the aluminum, will prevent excessive moisture inside the panels.

Once a year the greenhouse needs to be completely washed inside and out. You should do this task when your greenhouse contains the least number of plants, generally just before the garden plants are brought in for wintering over. A recommended cleaning solution is a mixture of soap and water, this will not damage your polycarbonate sheets. Any benches, shelving, plastic trays, pots and baskets should also be cleaned thoroughly. *Prevention is the best known method for controlling pests and diseases in the greenhouse.*

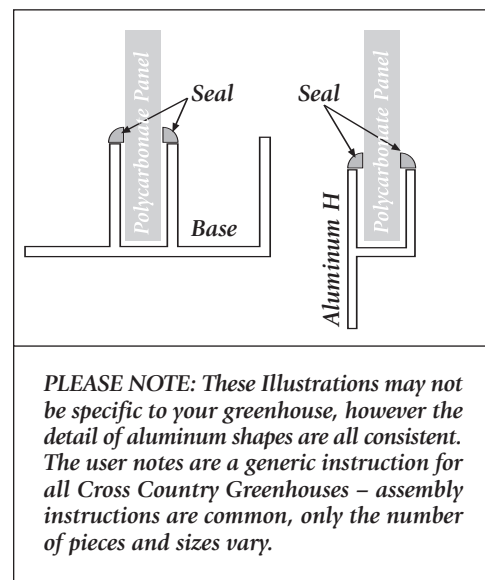

PLEASE NOTE: These Illustrations may not be specific to your greenhouse, however the detail of aluminum shapes are all consistent. The user notes are a generic instruction for all Cross Country Greenhouses – assembly instructions are common, only the number of pieces and sizes vary.

NOTE: DO NOT STORE POLYCARBONATE SHEETS IN THE SUN.

Your Cross Country greenhouse is designed and constructed to the highest engineering standards and provides structural strength and maintenance-free service for year-round gardening pleasure.

The Cross Country greenhouse must be built upon a firm, level surface. The greenhouse foundation or sill can be made from pre-treated timbers, concrete or bricks. Whatever your choice of material, the base must be square and level.

When selecting a site for your greenhouse, keep in mind that a flat, level site is essential so that the greenhouse can be easily installed and the complete structure is stable and secure. If possible, choose a site with proper water drainage.

Locating the greenhouse in a north-south position is most suitable for raising summer and autumn crops since the sun's rays will be on the greenhouse from daybreak until sunset. An east-west position is ideal for early spring and winter crops since the winter months, with shorter daylight hours, still allow six hours of light exposure to the greenhouse.

Try to locate your greenhouse for easy access, especially to the necessary power and water that is required for greenhouse gardening.

Please watch the enclosed video and follow the steps in this manual for your greenhouse installation. *Remember, if all else fails, read the instructions.*

User Notes

The Cross Country greenhouse structure has been designed to withstand extreme weather conditions such as high winds and accumulated snowfall. Hanging baskets and sidewall shelving can also be attached to its sturdy frame. The greenhouse design also makes it possible to add extra sections at a later date.

Once a year the greenhouse needs to be completely washed inside and out. You should do this task when your greenhouse contains the least number of plants, generally just before the garden plants are brought in for wintering over. A recommended cleaning solution is a mixture of soap and water, this will not damage your polycarbonate sheets. Any benches, shelving, plastic trays, pots and baskets should also be cleaned thoroughly. *Prevention is the best known method for controlling pests and diseases in the greenhouse.*

Cross Country Component List

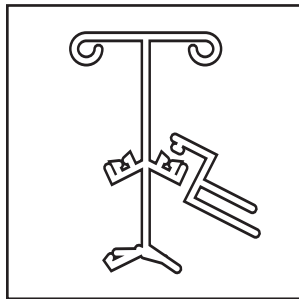

Ridge & Ridge Slider

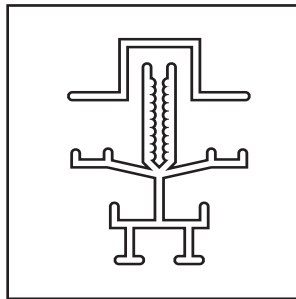

Poly Cap & Poly Bar

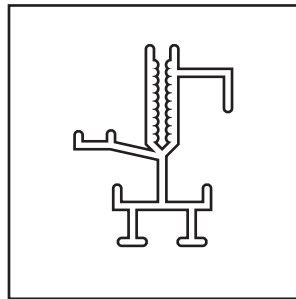

Poly End Bar

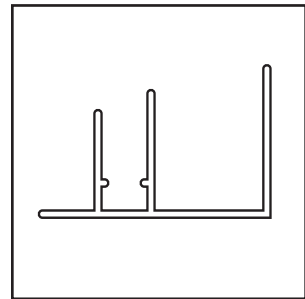

Ventframe Bottom Side Base/Sill

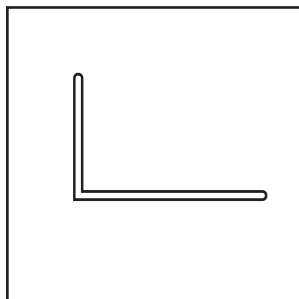

Bracing Angle

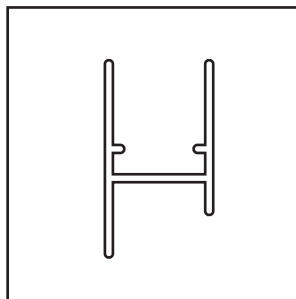

Aluminum H

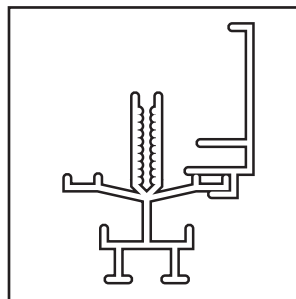

Vent Frame Sides

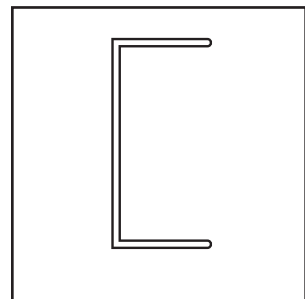

Purlin

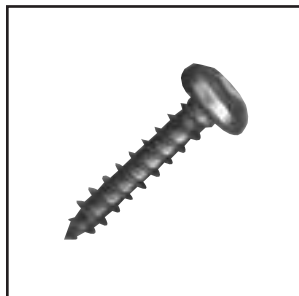

Screws

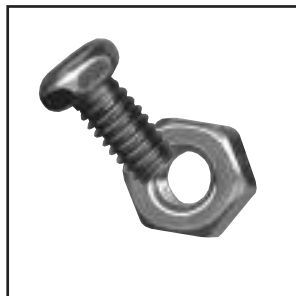

Bolt

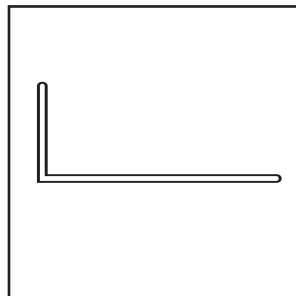

Front & Back Base/Sill

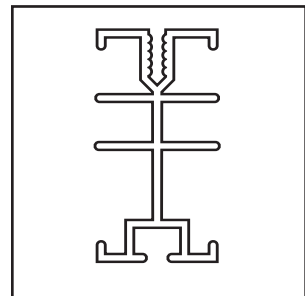

Door Frame

Tools

- #2 Square head screw driver (#8 Screw)
- Measuring tape
- Level to check foundation
- 3/16" concrete bit (concrete foundation)
- 9/64" aluminum bit
- 7/16" wrench
- Razor blade cutter
- Caulking gun
- Ladder
- Hammer

Optionals

- Automatic Opener
- Circulating Fan
- Max/Min thermometer
- Benches
- Eyebolts
- Motorized Intake Shutter
- Exhaust Fan
- Thermostat
- Heater
- Side Vent

Foundations

Check your local building codes for foundation requirements in your area.

CONCRETE FOUNDATIONS

When you prepare the concrete foundation, the size should be exactly the same as the outside dimensions of the greenhouse.

PRE-TREATED WOOD FOUNDATIONS

A greenhouse that is approximately 100 sq. ft. (9.3 m²) can be fastened to a 4" x 4" pre-treated wood timber foundation. For larger greenhouses, a 6" x 6" wood timber foundation is recommended. These timbers are placed on a 4" (10 cm) deep and 8" (20 cm) wide gravel bed. Wood timbers can be stacked to increase the height of the greenhouse. *One advantage of the wood foundation is that it is not classified as a permanent structure. Therefore, if you move, the greenhouse can be dismantled and moved to another location. IMPORTANT NOTE: Please see the last page of this manual for important information regarding the 'New' Pressure Treated wood.*

A SQUARE AND LEVEL FOUNDATION

Check the width and length of the foundation's outside dimensions. Then, square the foundation by measuring diagonally from opposite corners in the form of an "X". Next, use a long carpenter's level to check and adjust the foundation until it is level. Finally, measure where the door will be placed (in most cases it is 34¹/₂" wide). Mark these measurements on your foundation.

Foundation Styles

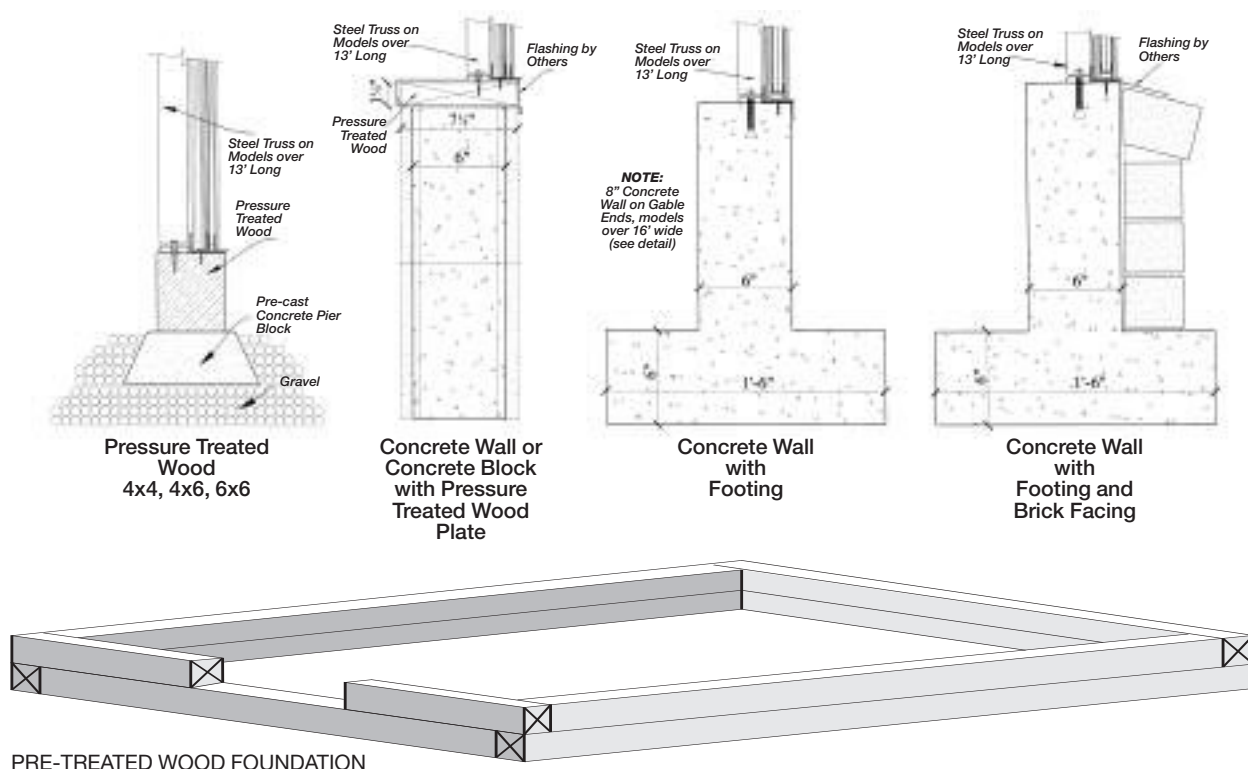

PRE-TREATED WOOD FOUNDATION

Assembly of Aluminum Frame

A. FRONT GABLE END ASSEMBLY WITH DOOR

Lay out the front pieces of the greenhouse into the shape of an end wall. The door frame and polybars have a track for the bolt. The track must face up when you assemble the gable ends. Slide the bolts in the track of the bars or use the notches that have already been punched out in the bars. *(Refer to the line/detail drawing.)* When you are assembling the greenhouse, you can view the sketches and drawings from inside the greenhouse.

1. Bolt the bottom plates (4 holes) to the base/sill and the door frame sides using 1/4" x 1/2" stainless steel bolts *(see Detail #1)*. Before tightening the bolts, be sure that it is square. *(If you ordered a greenhouse with a door drop, measure from the bottom of the door frame to the underside of the base according to the specified distance.)*
2. At the top of the door frame, put on the door frame header (which looks the same as the side pieces). Put the header between the two side pieces and bolt on the plates (6 holes). *(See Detail #2.)* The plates should stick up 1" above the door frame. Note how the plates are put on. *(See Detail #2.)* Before tightening the bolts, be sure to square up the door frame.
3. Take all the polybars and bolt them to the base/sill. The angle cut should match the roof slope. *(See Detail #3.)*
4. The 1" x 2" angle above the door (50" long) can now be bolted on. The 1/4" round holes should be lined up with the holes in the plates. Each end of the 1" x 2" angle has a slot punched out to accommodate the bolt that is lined up with the polybars 24-1/2" from the center. Slide a bolt in the top of the polybar and fasten the angle to it. *(See Detail #4.)*
5. Each curved poly end bar has at least one small aluminum piece attached to it with a 1/4" hole drilled in it. These pieces line up with the upright polybar(s). Both sides are the same. *(See Detail #5.)*
6. When both polybars are fastened tightly to the underside of the curved poly end bar, bolt on the short center bar above the door to the angle above the door. Do not worry about the small cleat bolted on the bar. This will be done later. *(See Detail #6.)*
7. The diagonal bracing can now be bolted on. Remove the bottom nut in the top plate and insert the brace. Then put the nut back on. *(See Detail #7.)* There are 1/4" holes in the base, so use 1/4" x 1/2" bolts. *(See Detail #8.)*
8. Be careful when you stand up the front end of the greenhouse because the poly end bar is quite loose. It may have only two bolts in it.

NOTE: *Temporary door frame spacer can be fastened to the bottom of door frame using a strip of wood. Make sure that the spacing is the same as the top of the door frame. This will keep the door frame from pulling apart when you pick up the end and move it around.*

Front Gable End (with door) Line Drawing Assembly Procedure

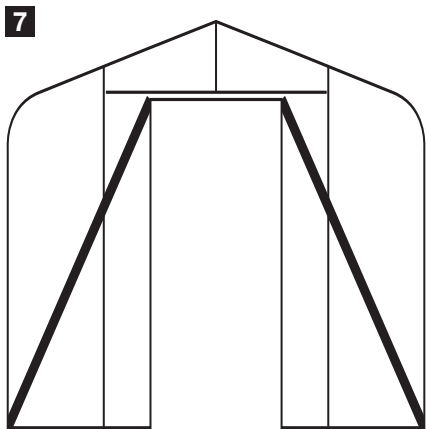
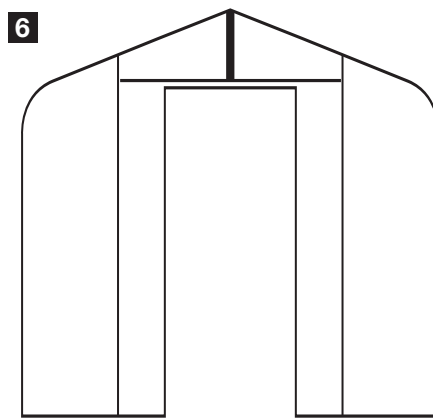
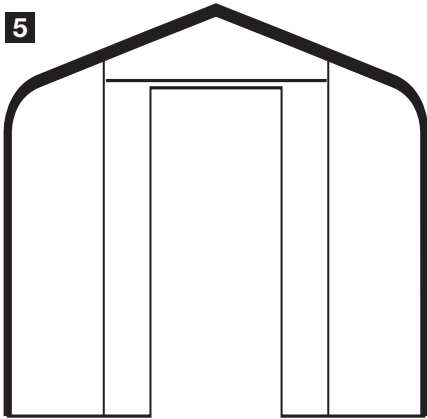
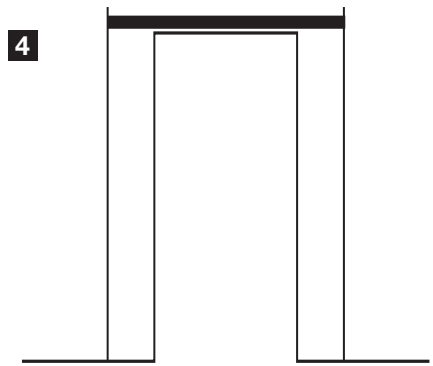
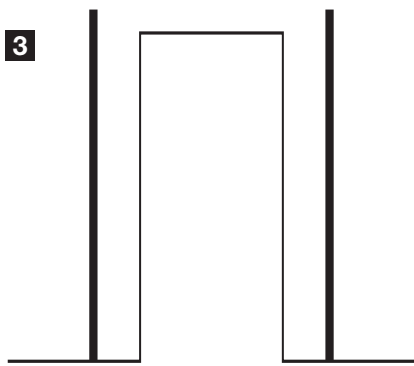
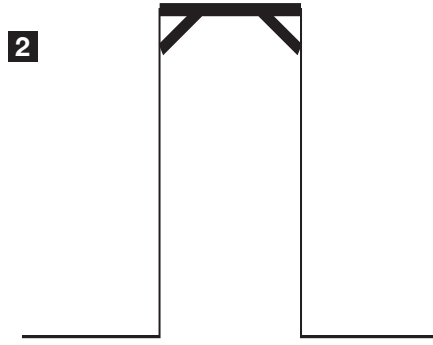
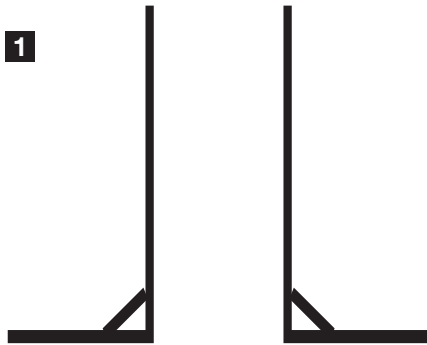

Front Gable End (with door)
Inside View Detail Drawings
Details 1-8

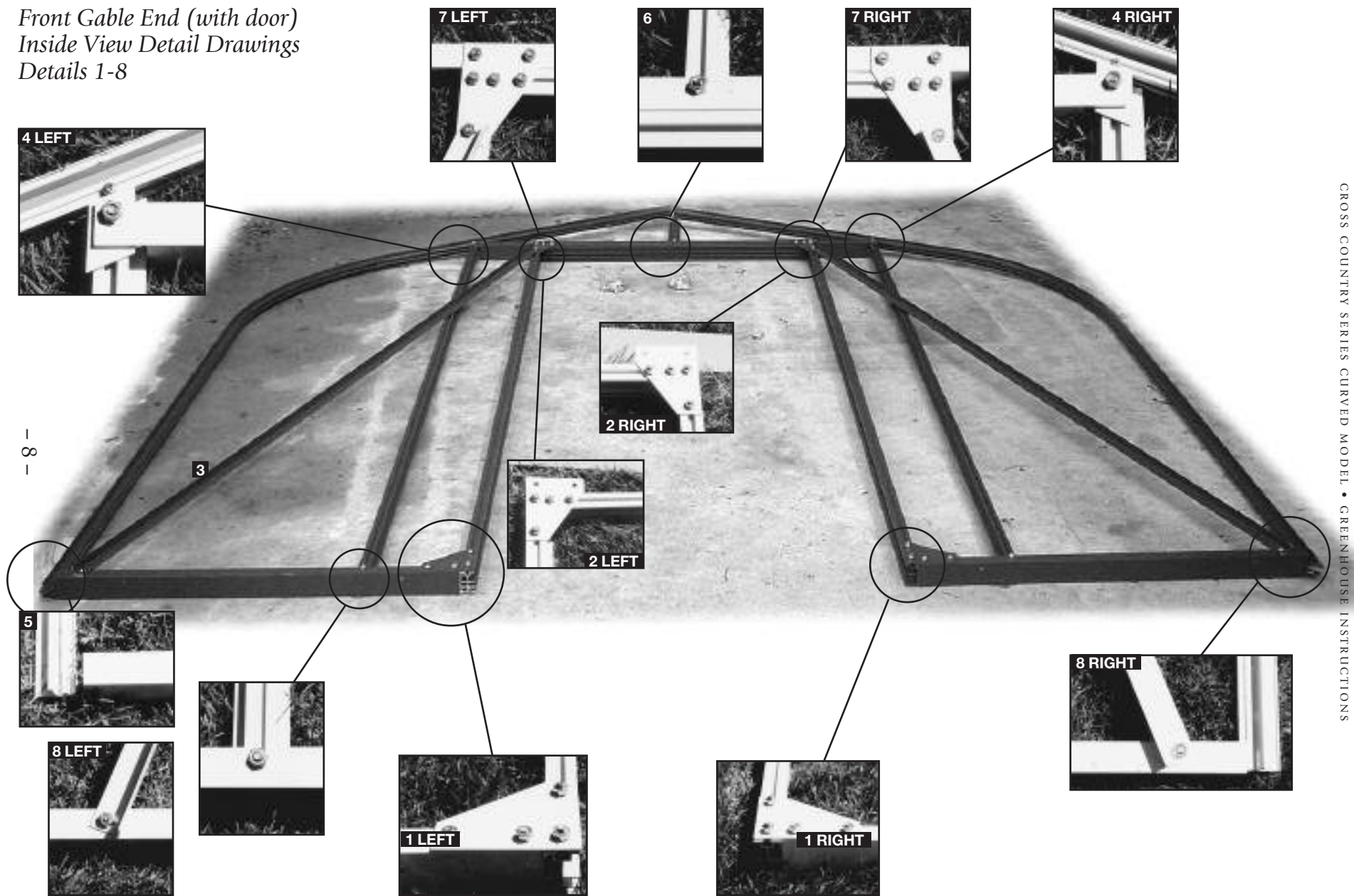

B. BACK GABLE END ASSEMBLY

Layout the back pieces into the shape of the endwall. *(Refer to the detail drawing.)*

1. For curved poly end bars, the flat surface should lie on the ground, as you can see in the example to the right.
2. Bolt the polybars on the top first. *(See Detail #9.)* The center polybar is not bolted to the top. You will notice an angle piece bolted to the top for fastening to the Ridge. *(See Page 15.)*
3. Bolt the base/sill to the bottom of the polybars. *(See Detail #10.)*
4. The angle brace is bolted horizontally approximately 48" from the base. The slider pieces that have already been screwed to the polybar end will determine the height. *(See Detail #11.)* When bolting the center of the backwall, measure it so that it does not sag. *(See Detail #12.)*

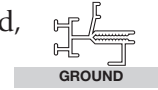

Back Gable End Line Drawing Assembly Procedure

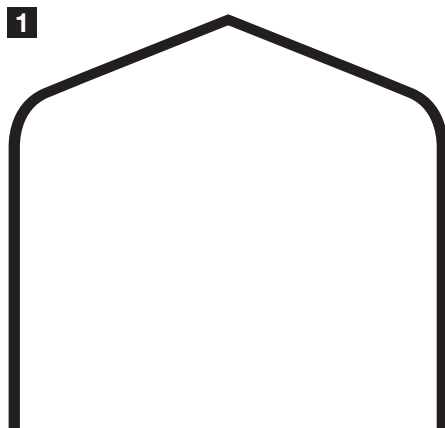

End Bars

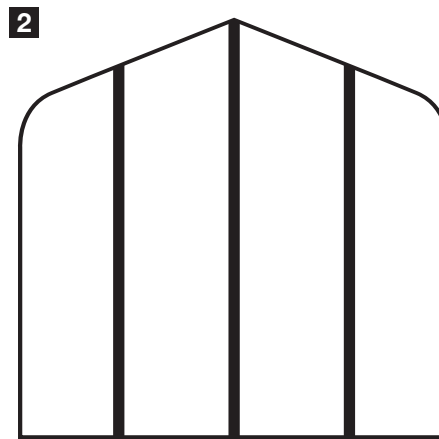

Poly Bars

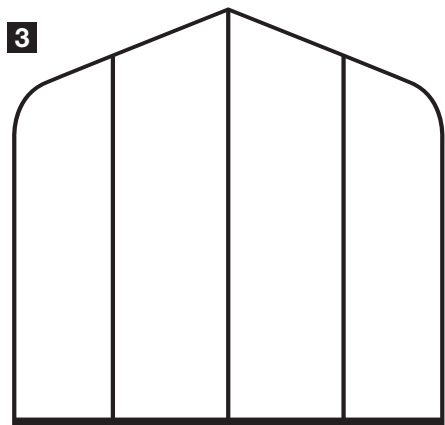

Base

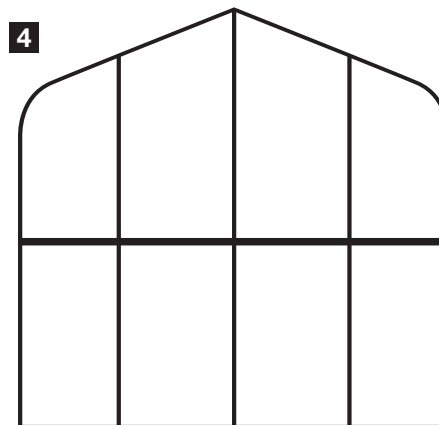

Cross Brace Angle

*Back Gable End
Inside View Detail Drawings
Details 9-12*

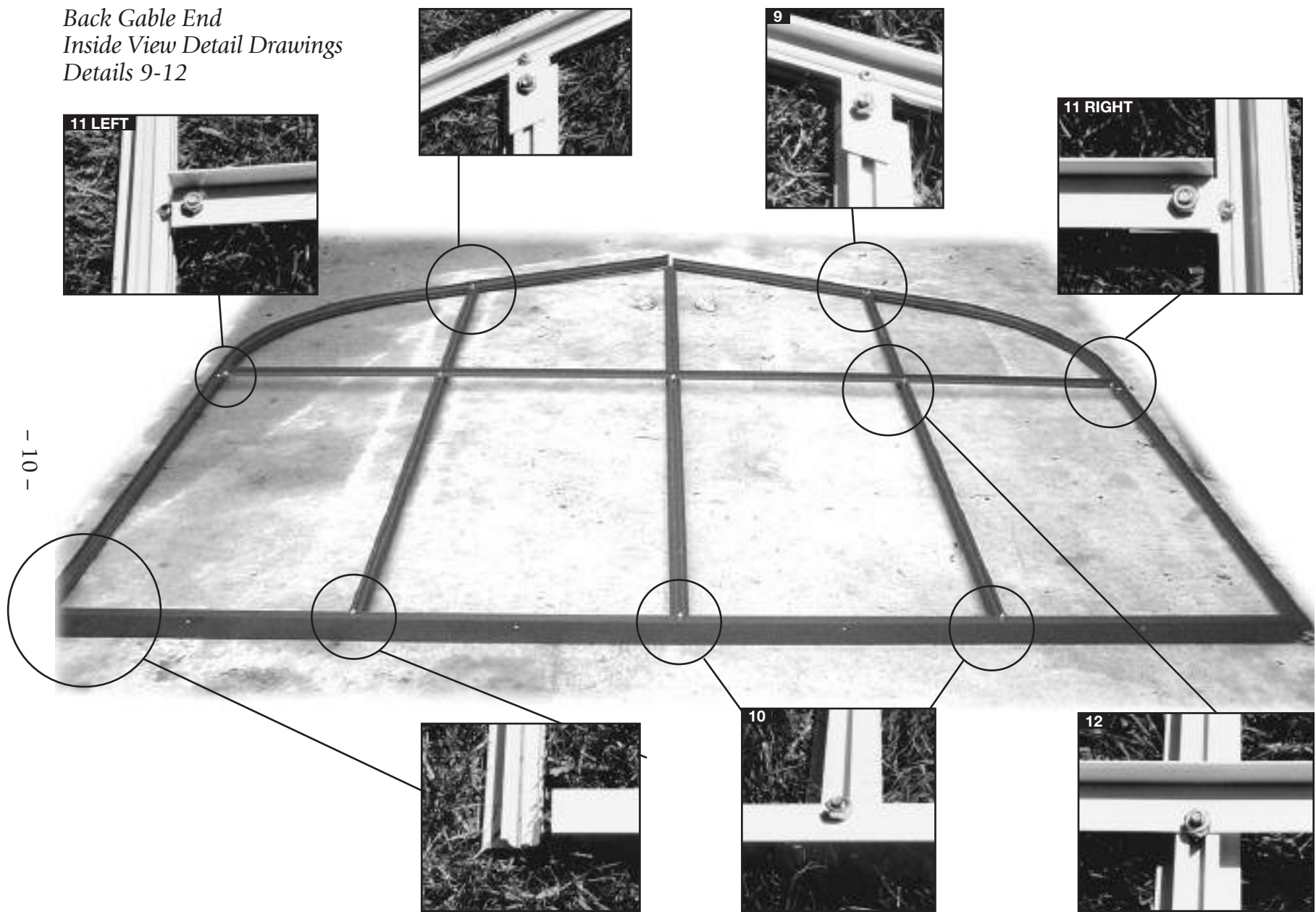

C. TAPING POLYBARS WITH FOAM

Tape all the aluminum polybars with a 1/8" foam gasket. Tape the poly end bars on one side only. (See Detail #13 & 14.) Tape all the other polybars on both sides. Take a roll and, starting at one end, press on the bar. *Make sure that the aluminum is dry.* (You should move all the pieces into a shed or undercover if it is raining.) Slowly roll down the tape toward the outer edge and press it down at the same time. (See Details #14A & B.) Be careful because sometimes the edge of the paper is quite sharp. Do not remove the paper until later. Do not tape where the polybar is notched out. (See Detail #15.)

NOTES: Taping can also be done either before (as shown in pictures to the right) or after the greenhouse is assembled.

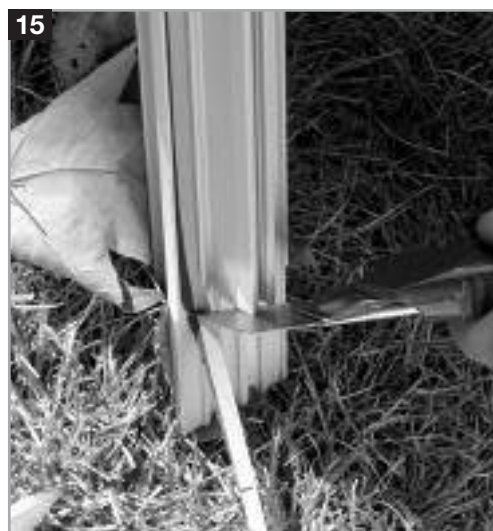

Do NOT put foam tape along the End Bars. The polycarbonate slides under the lip and needs to be sealed when the greenhouse is finished

Aluminum Frame Installation

Check that the foundation is level and square. If your foundation is larger than the greenhouse, mark a line on it with a pencil or with a chalk line. Take a caulking gun and put in a tube of caulking. Cut 1/4" off the top at a 25-degree angle. Then put a bead of caulking on your foundation approximately 1" in from the outside of the foundation or the marked line. **DO NOT CAULK THE DOOR OPENING.** Measure your door opening in the front.



1. SIDE BASE/SILL

Lay down the aluminum side base/sill flush with your base or on the line you have marked. Push down on it so that the caulking squeezes out. *(See Step 1 Detail, page 14.)*

2. FRONT GABLE END

Stand up the front gable end between the side pieces. Again, make it flush with your base or marked line. Slide one bolt into the bottom of each curved poly end bar (front). Take the curved end bar and push it into the side base where it is notched. The back of the bar lines up with the first slot in the side base/sill. Slide down your bolt and fasten it. Do the same with the other side. When you have lined it up and it is in the correct place, screw down the front base/sill using the screw holes that are already there (#8 x 1"). Then put one screw in the side base on each side of the front gable end. When you have fastened down the front, it should stand by itself. (If it is windy, you need another person to hold up the front, or you can use a stepladder so that the front can lean against it.) *(See Step 2 Detail, page 14.)*

3. BACK GABLE END

Follow the same procedure for the back gable end as for the front. When you have bolted the gable end to the side base and it lines up flush with your base/sill or marked line, then you can proceed. Fasten down the base/sill to your foundation using the screws that are provided. When fastening the side base/sill, make sure that it is straight. *(See Step 3 Detail, page 14.)*

4. RIDGE

Take the ridge (one person at each end) and slide it between the end bars on the top. You will notice the punched-out slots in the bottom flange of the ridge. The end slots must line up with the bottom side of the end bar. Before you slide in the ridge, put one bolt in the top of each end bar. Now slide in the ridge and slide the bolt into the ridge slot. Make sure that the poly end bar is tight against the ridge.

4A. SEE APPENDIX A FOR TRUSS ASSEMBLY INSTALLATION, IF REQUIRED

(See Step 4 Detail, page 15.)

5. POLYBAR WITH SLIDERS (#1 or #2, etc.)

Each polybar (beside the vent opening) is marked with a number (1 or 2, etc.) to correspond with the number on the ridge. Slide the bolt into the top of the polybar and line it up with the slot in the ridge. Move up the bolt and fasten it. Do the same for the bottom of the polybar. Slide in the bolt, lift up the end, and push it into the side base/sill as far as you can. Then bolt it on. Do this for all the polybars with sliders and numbers. *(See Step 5 Detail, page 16.)*

6. VENT FRAME ANGLE (Approximately 20" Down From The Ridge)

The vent frame angle is 50" long with the ends cut out to fit between the two polybars with sliders. *The vent frame is the same shape as your base/sill.* Put the head of the bolt into the punch out (24" from the top), slide the bolt up and fasten it to the vent frame on the bar. Make sure that the angle flanges are facing the sidewall (down) and that it is pushed tightly against the sliders. Do this for all of them. *(See Step 6 Detail, page 17.)*

7. POLYBARS

Bolt on all the remaining polybars. Make sure that the top and bottom are *tight* against the aluminum (base/ridge). *(See Step 7 Detail, page 18.)*

8. SIDE BRACE (ANGLE)

A side angle horizontal brace is used as a spacer bar just below the curve approximately 44" up from the base. Again, just slide the bolts up and fasten them. It really does not matter which way this angle is facing. *(See Step 8 Detail, page 19.)*

9. ROOF PURLIN (CHANNEL)

When installing the roof purlin, mark it out by measuring from the ridge approximately 6" above the place where the curve starts. In larger greenhouses, the purlin may be located about the center between the ridge and the top of the curve. Always face the open end up towards the ridge so that it can be used for hanging baskets. Every polybar has notches punched out so that the head of the bolts can be inserted and can slide up or down along the bar. *(See Step 9 Detail, page 20.)*

10. CENTER BARS (FRONT AND BACK)

Now you need to fasten the center polybar in each end. Use a 1" x 2" x 1" small angle with a 1/4" hole drilled in the 2" side. Put a bolt in the center polybar and attach the small angle to it. Slide it up to the ridge. *It is on a 24-degree angle.* Clamp it on with vice grips. Then drill a 9/64" hole in the ridge and screw it on. Make sure the polybar lines up the same as the other bars in the front and back. *The 10' Cross Country Model does not have this center bar in the backwall.* *(See Step 10 Detail, page 20.)*

11. TAPE ALL POLYBARS

You are now ready to tape on the 1/8" foam gasket, if you have not done this already. *(See photographs, page 11.)*

11A. SIDE VENTS, INTAKE SHUTTER AND EXHAUST FAN INSTALLATION (IF NECESSARY).

See Appendixes B thru E. THEN RETURN TO THE NEXT PAGE AND CONTINUE

– Assembly Outline –

Step 1: Side Sill & Base



Step 2: Front Gable End

Step 3: Back Gable

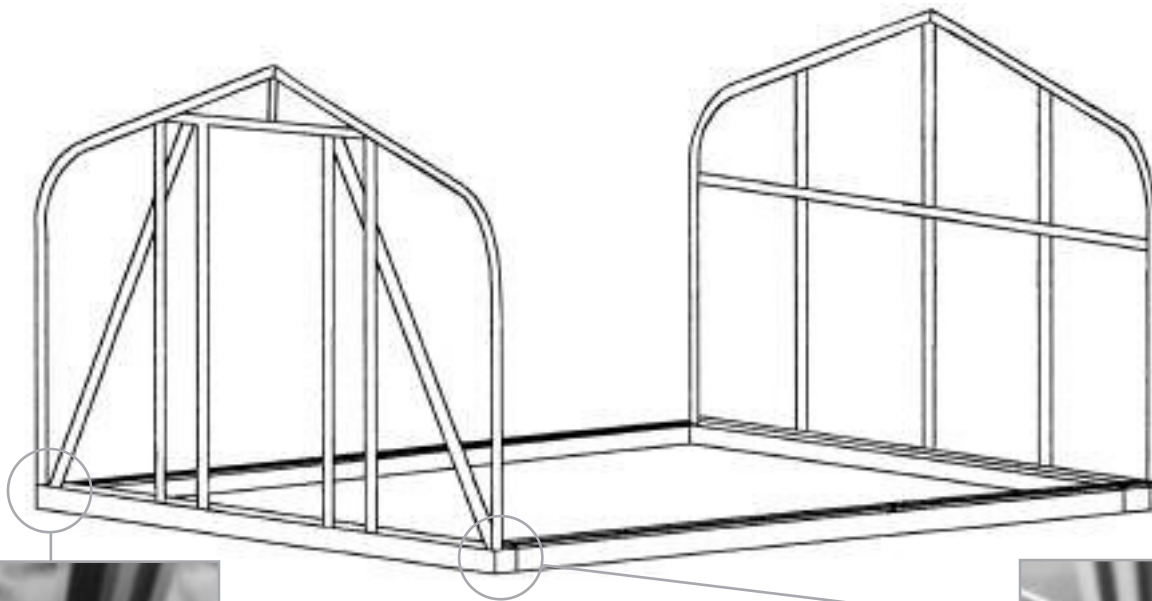

Step 4: Ridge

Front View



Inside Back View

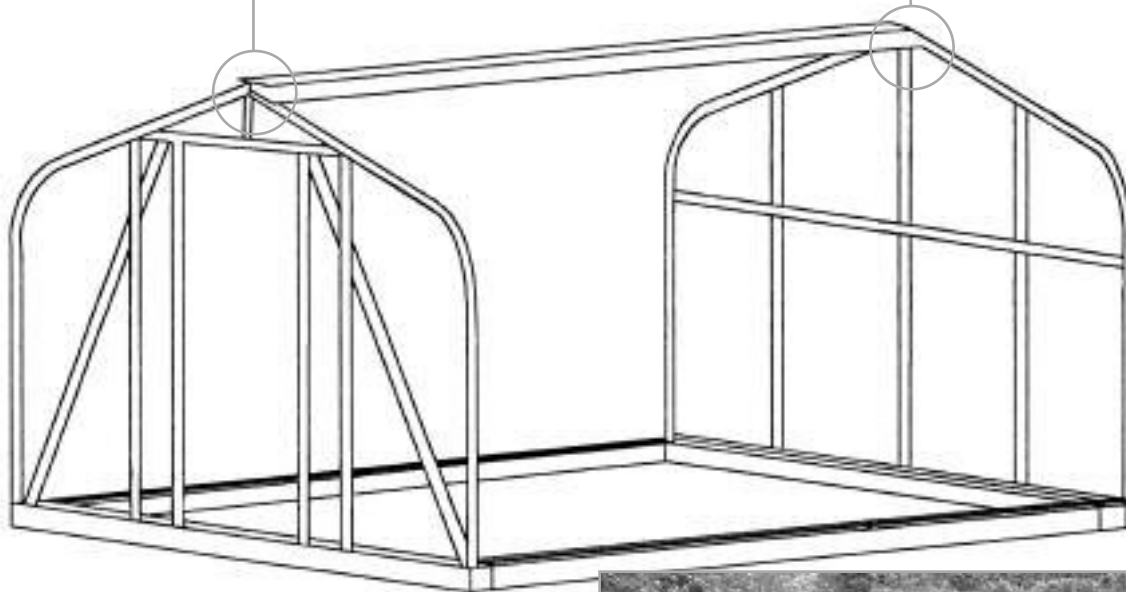

*Step 5:
Polybar with
Vent Frame Siders*

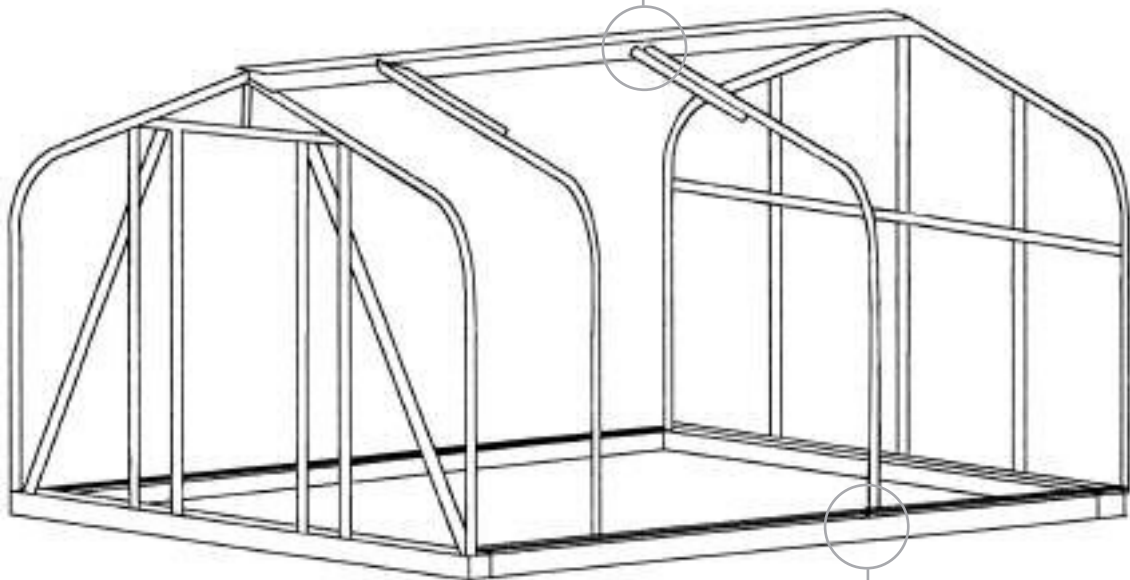

*Step 6:
Vent Frame
Bottom*

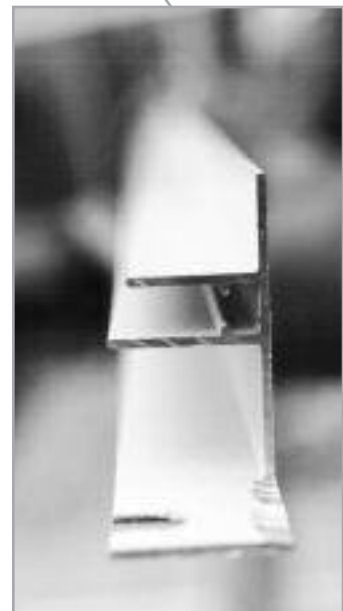
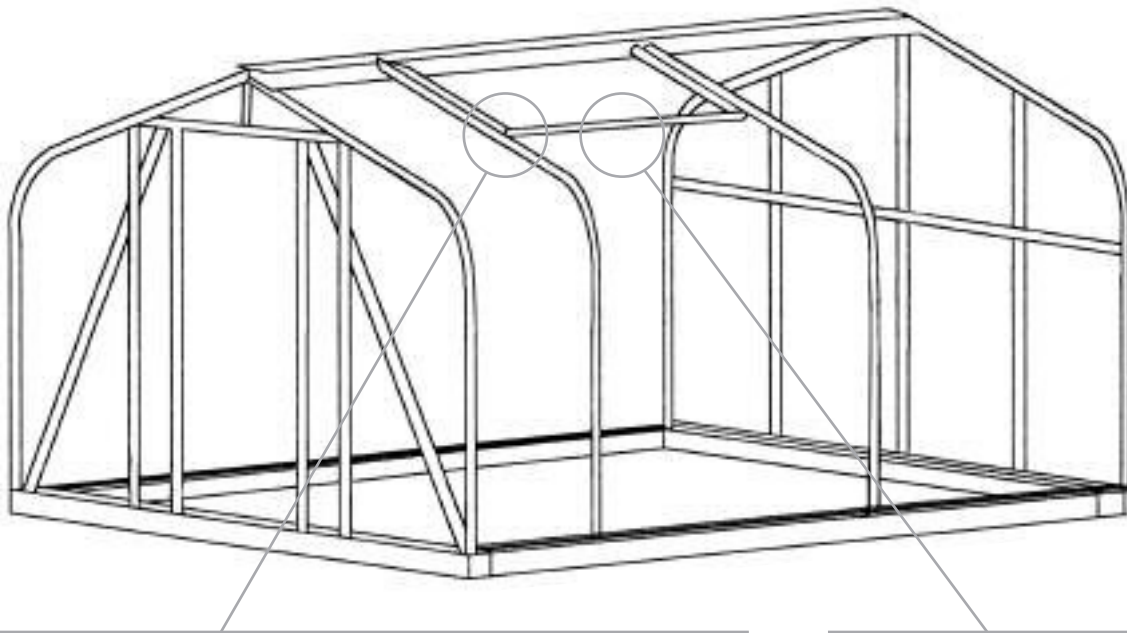

Step 7: Install all remaining Polybar

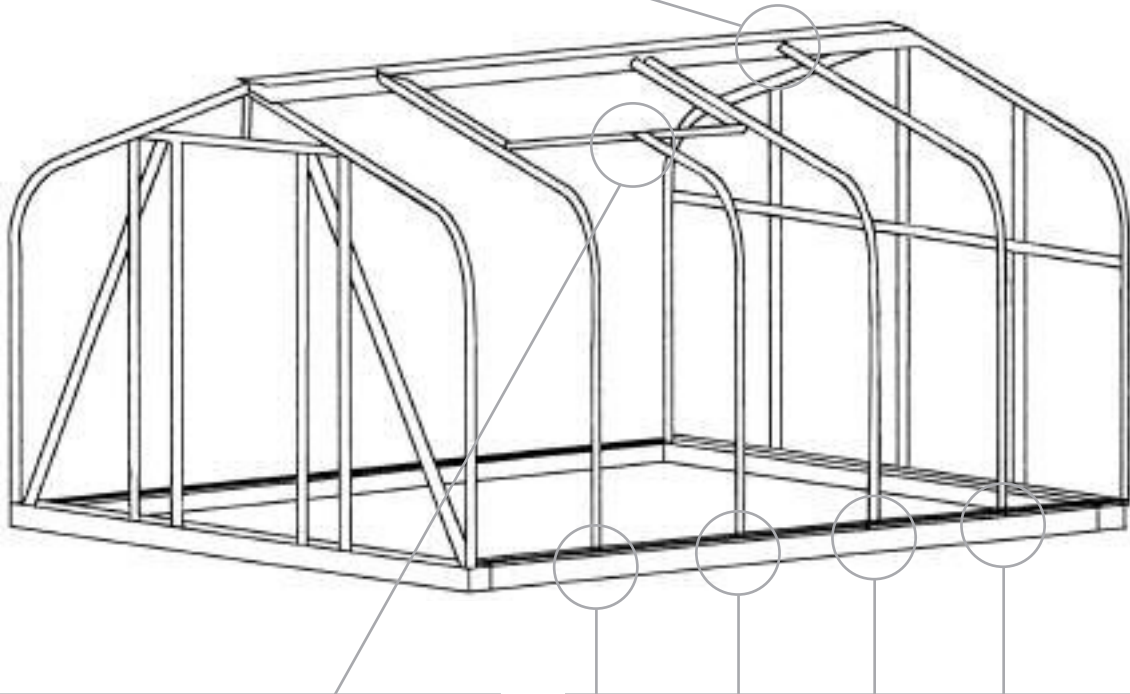
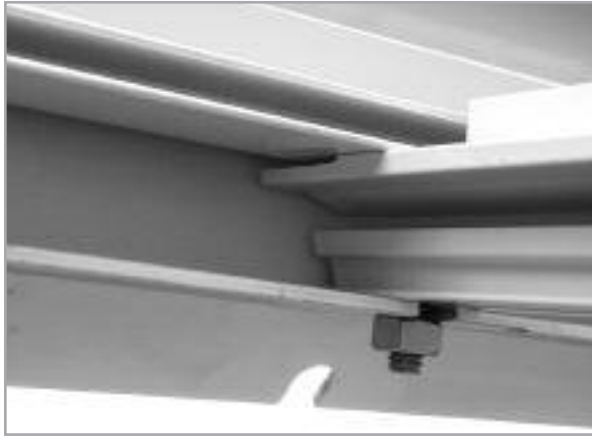

Step 8: Side Braces

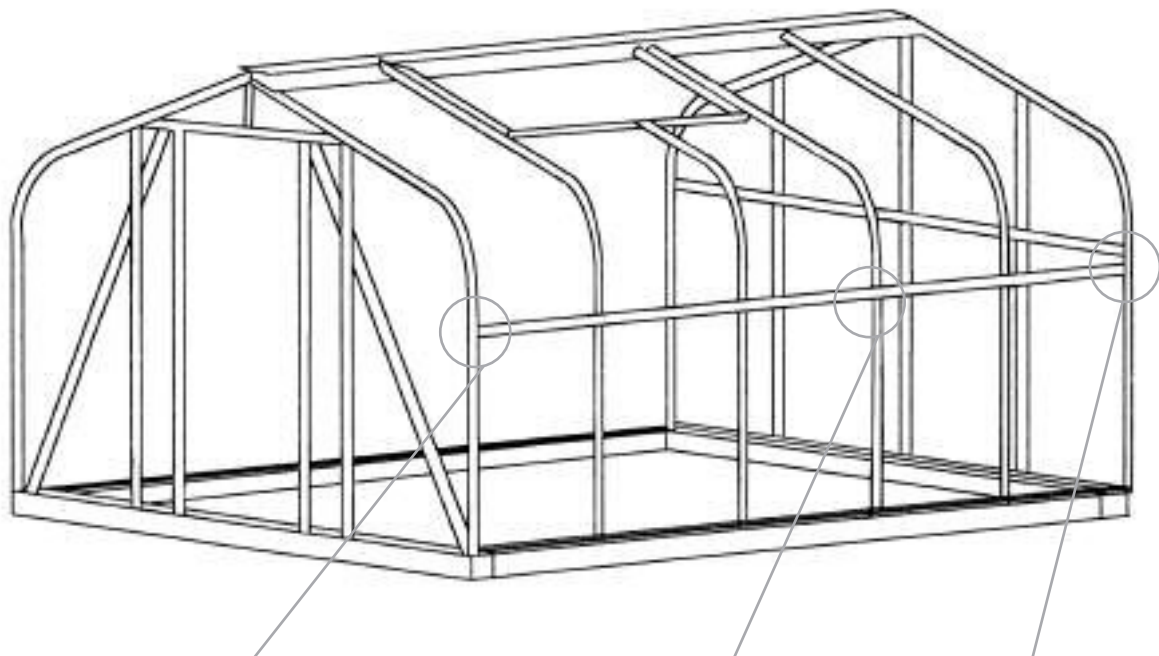

Step 9: Roof Purlin

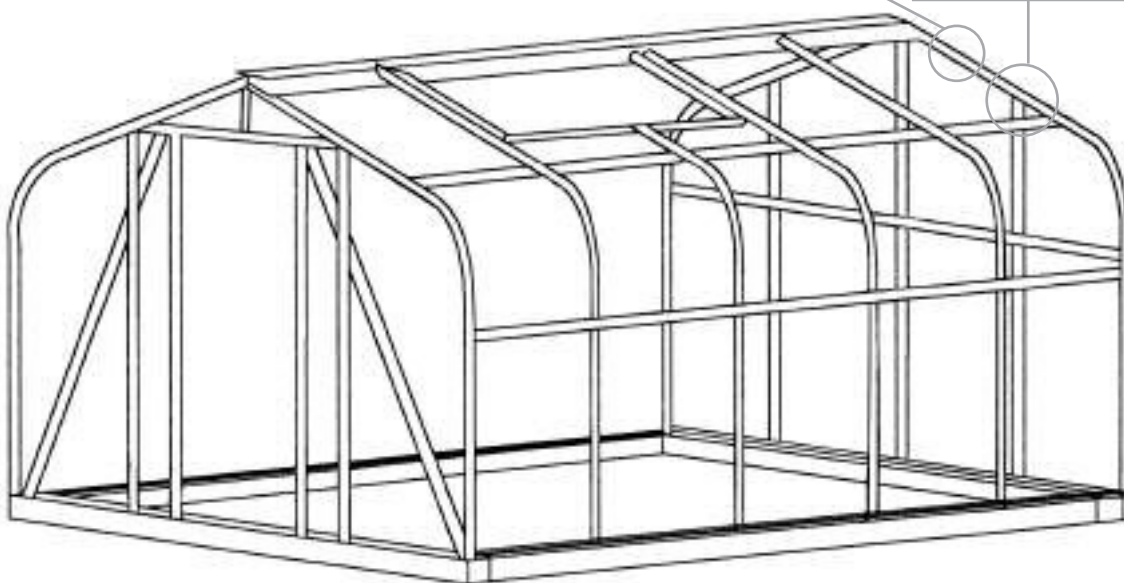

Step 10: Inside View Angle Cleat to Ridge

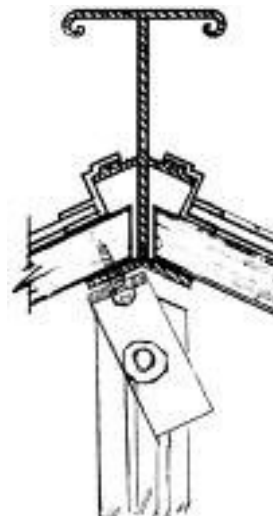

Polycarbonate Panels & Cap Installation

GENERAL INFORMATION ABOUT HANDLING POLYCARBONATE

All polycarbonate sheets are covered with a thin sheet of plastic on both sides to prevent the sheets from becoming dirty and scratching during handling. One side is a clear plastic while the other side is blue or some other colour, depending on the manufacturer. This latter side should be installed so that it faces out. (The sheet is marked to indicate which side should face out.)

Before you begin installing, lay out the sheets lengthwise so that it is easier to take the one you want to install. Do the same with the capping.

Remove all the paper on the foam strip on the greenhouse before you begin installing the panels. If the weather is warm and sunny, the foam strips will be sticky. Take a trigger spray bottle and fill it with soap and water. Just before you install the panels, spray the foam lightly so that the panels can be moved around.

(Do not store polycarbonate bundles outside in the sun. Instead, store them in a cool dark place, such as a garage, until you are ready to use them.)

12. SIDE WALLS

Start with the first long panel and peel off the plastic. Remember to mark in the corner which side is out. Stand the sheet up into the bottom track of the side base/sill. Push the panel against the foam. If the polybars do not line up with the panel, move the greenhouse ridge toward the front or back until the bars line up.

Take the cap, hold it against the panel and position it in the center of the polybar.

Note: Use #8 x 1/2" screws and fasten the cap to the bar (approx 3 to 4 screws to the curve)

Continue to the next panel and follow the same procedure.

When you have completed one side, make sure that the length of the panels are correct. The panels should be approximately 20" shorter at the place where the vents go. (See page 22.)

Now go back to the first panel, and at this point you need an assistant.

He/she should take a ladder and set it below the ridge. Walk up the ladder, lean over the ridge and take the end of the sheet while you start pushing it around the curve. As you push the sheet down on the polybar, your assistant needs to guide the top end of the sheet into the ridge slider track. At this point, if the greenhouse is not square, move the ridge to the front or back to square it. After the sheet is in place, your assistant should hold it down while you take the cap and bend it over the curved bar.

Note: When bending the cap around the curved part of the polybar, do it slowly and put in the screws as you go along. If you push too fast, the cap may buckle. Keep it in the center put in the screws as far as you can reach. Then your assistant can take over. Do this with all the sheets. (If it is windy while installing the panels, you may need to finish off each panel as you move along.) (See page 23.) Follow the same procedure for the other side.



Step 12A: Side panels

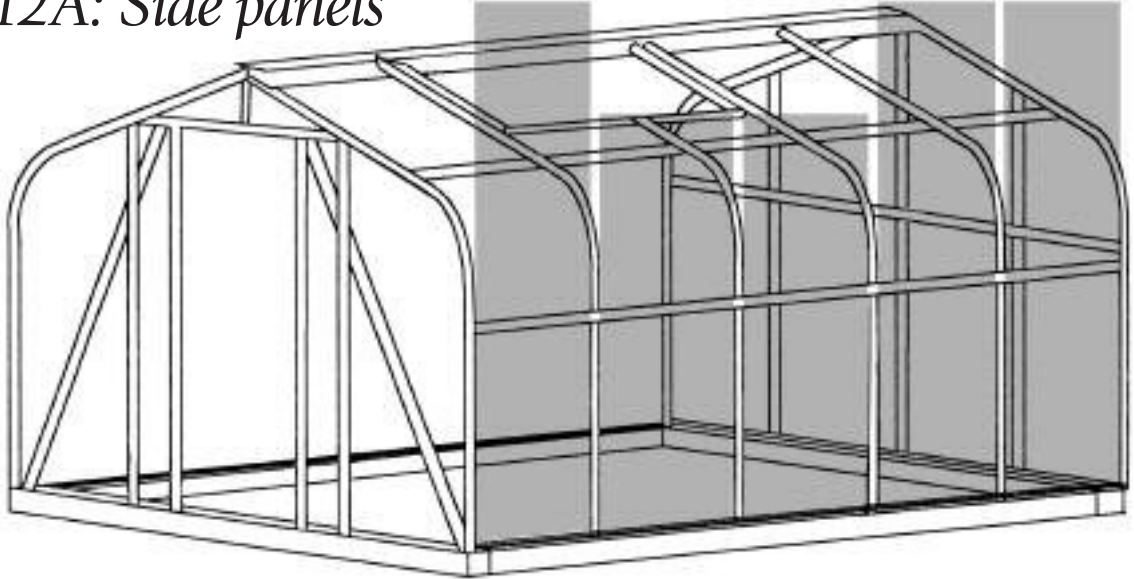

Step 12B: Side panels

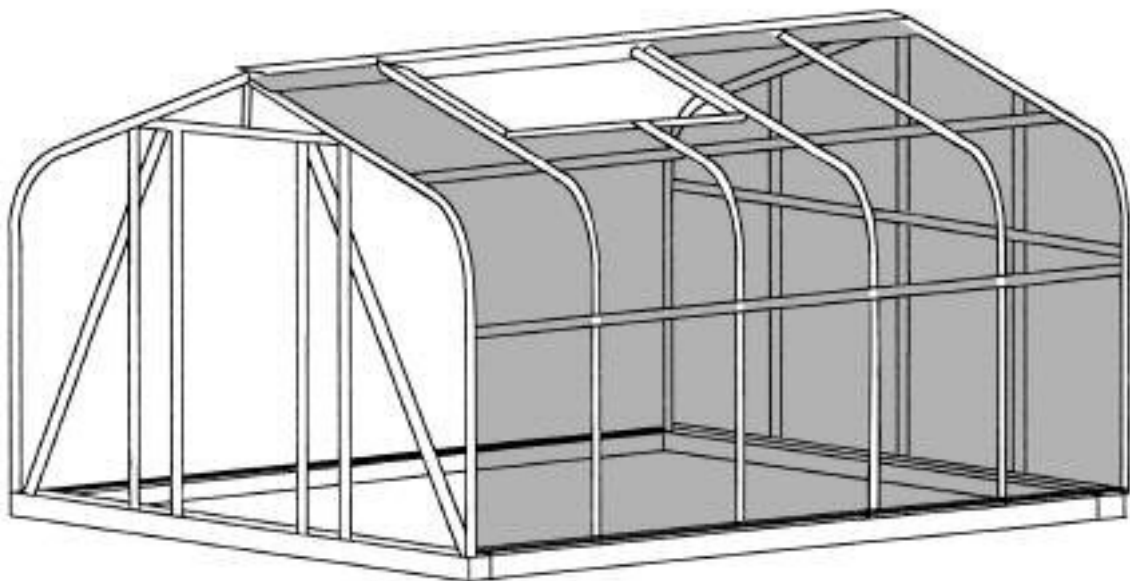

13. DOOR END WALL

Start with the round panels and peel off the plastic. Remember which side is the outside of the sheet. There is a right and a left panel. Put on the bottom of the panel an aluminum "H" (page 25, picture **1**). Stand up the sheet and push it sideways into the end polybar track (page 25, picture **2**). Start with the bottom and move upward. You will have to twist the panel to get it in. Another way to accomplish this is to remove the polybar beside the sheet, push the panel into the end track and then rebolt the polybar back into place.

For the next panel, put an aluminum "H" on the bottom (face the flat side out – see page 25, picture #2). Stand it up in place, bend the center of the panel toward you and pop the top of the panel into the track. (You can also slide the panel in the top track first and then push the bottom in place.)

Put the cap on the bar and screw on with #8 x 1/2" screws. Do the other corner the same way. The panels beside the door are usually narrow pieces and have an aluminum "H" on the top and the bottom. (The aluminum "H" does not slide into the door frame track.) Also, make sure that the second track (in the door frame) is used; otherwise, the panel will sit on an angle (page 25, picture **3**). Finish off the door end.



14. BACK END WALL

Again, start with the outside corner just as you did with the front wall. Remember to put the piece of aluminum "H" on the bottom. Sometimes the "H's" are loose and at other times they need to be hammered on. The reason is that each manufacturer of this product has a slightly different thickness of the polycarbonate sheets.



Inside view

15. SEALING THE GREENHOUSE

When all the polycarbonate sheets are installed, take a tube of clear silicone sealant and seal all the panels that fit into the aluminum tracks on the top, the bottom, the inside and the outside. In this way, you can keep out most of the moisture from the end of the panels. If this sealing process is not done, water will sit in the bottom, fill the inside of the panels and grow algae.

1. Unscrew the plastic nozzle on the tube of silicone sealant.
2. Cut the top of the tube.
3. Screw on the plastic nozzle again.
4. Cut approximately 1/8" off the end of the plastic nozzle at a 30-degree angle.
5. Put the tube into the caulking gun. When using the gun, squeeze the handle slowly.
6. Seal all the panels where it fits into an aluminum track. Top, bottom, inside and out. You're trying to keep most of the moisture out of the end of the panels. If this is not done, water will come in the bottom inside of the panels and create algae.
7. Seal the vents before you slide them into place.



Outside view



Roof

Steps 13 & 14 – Polycarbonate Installation

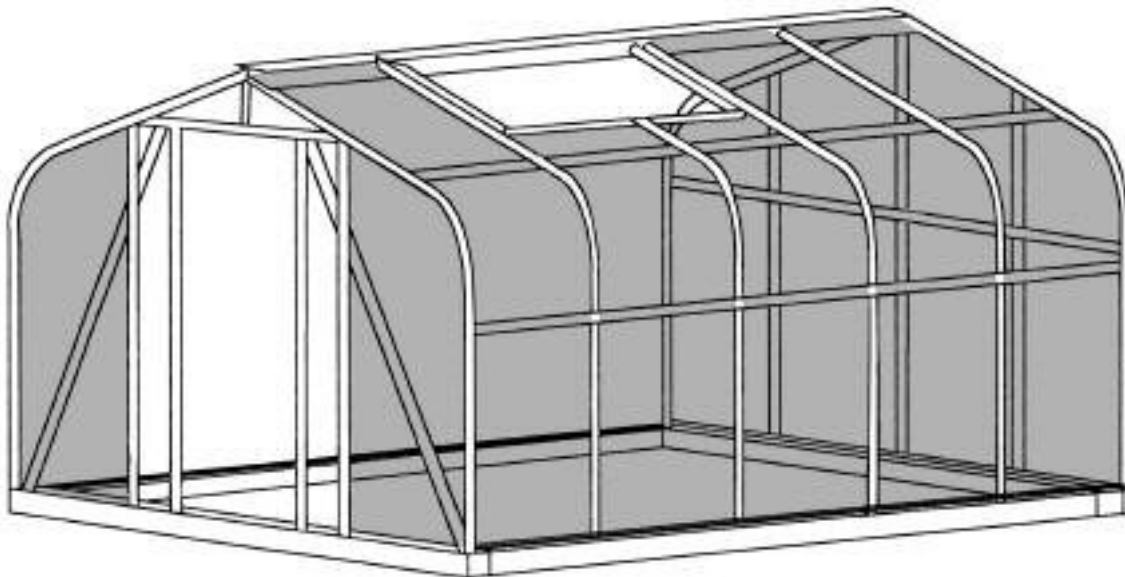
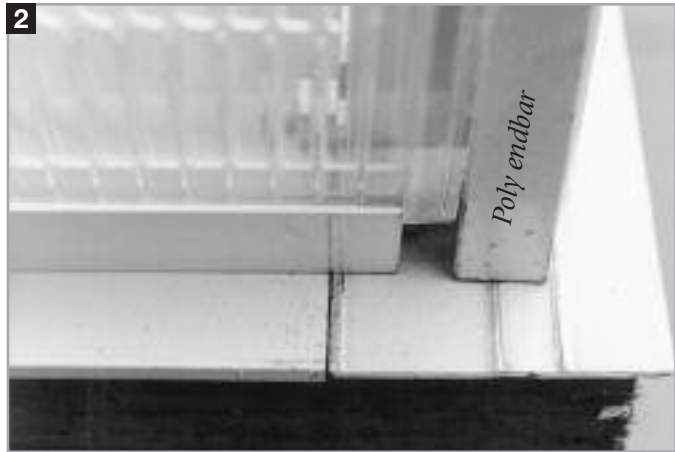

16. DOOR INSTALLATION

(Refer to the drawing.) Take the door and set it inside the door frame. Lift it up as high as possible on the hinge side and put the screws through the existing holes in the door frame. Now the door will hang by itself.

Remove the black clip from the "Z" bar and put one screw into the door frame to hold the "Z" bar. Open the door, take off the clips and put back the screws. Close the door and check that it is square. If the frame and the door are square, then fasten the "Z" bar to the frame. If not, move the "Z" bar up or down to square it. If this is not enough, loosen the bolts in the top plates and move the frame to make it square. When it is in place, tighten all the bolts.

Next install the door handle (see the instructions inside the box). To install the door catch angle, slide in two bolts into the back of the door frame. Bolt on a small angle (provided with the door handle). Face the angle towards the door, line it up with the center of the door handle, and then tighten the two bolts (see picture to the right). Take the door catch out of the door handle box and screw it on. Close the door and adjust the door sweep at the bottom of the door to eliminate potential gaps.

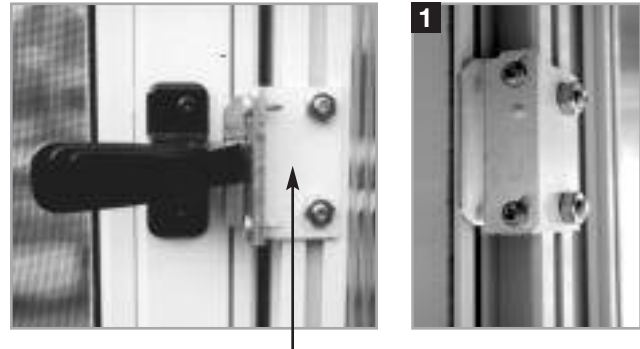

Door Catch Angle

NOTE: There are two types of manufactured doors. The door catch angle on the white door may have to be turned the opposite way as shown on picture **1**.

Run a bead of silicone under the angle above the door and against the door frame. Also silicone the "H" on the polycarbonate beside the door to ensure an airtight seal.

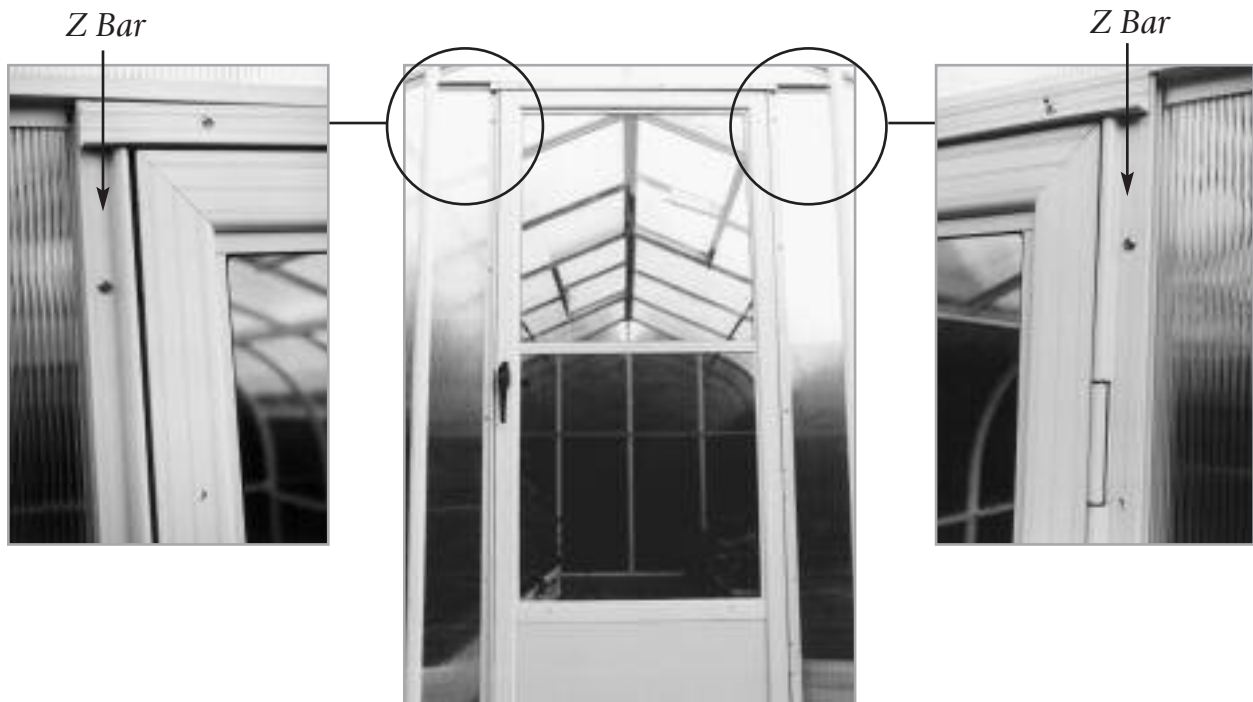

Door Installation

- 27 -

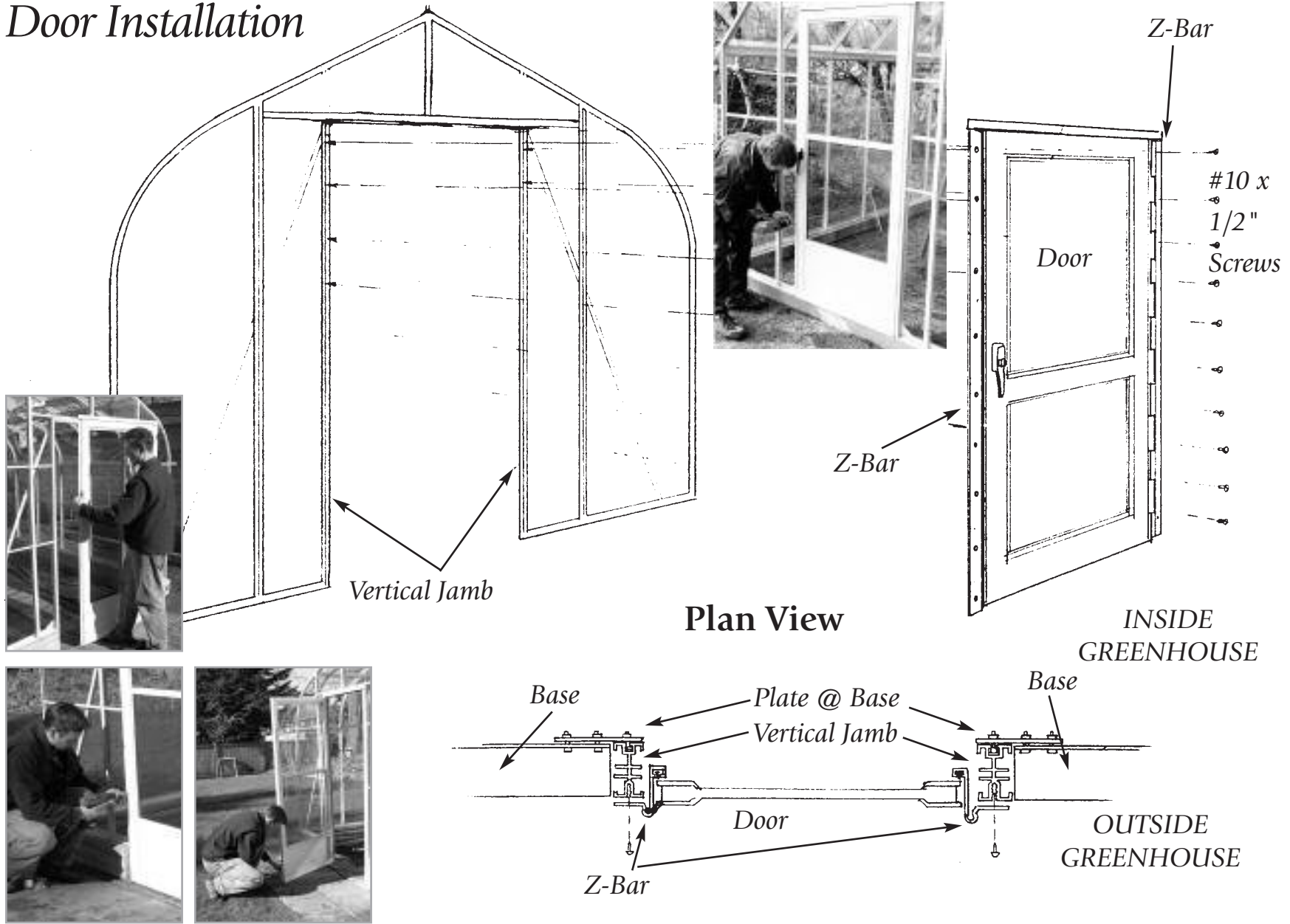

CROSS COUNTRY SERIES CURVED MODEL • GREENHOUSE INSTRUCTIONS

17. VENT ASSEMBLY (SEE DRAWING & PICTURES PAGES 29 & 30)

1. Lay down the gutter with the punches facing up towards you.
2. Polybars with sliders on are for the end. Lay them down with the bolt slot facing up.
3. Hinge with punches facing up towards you.
4. Slide the bolts into both ends of the end bar. Take the gutter and line up the bolt with the 1st punch, slide the bolt down and tighten it. Do the same with the hinge, other side and center bar. Make sure that the polybars are tightly fitted to the gutter and hinge after vent assembled.
5. Turn it over and square it up.
6. Put 1/8" foam on the polybars.
7. Take polycarbonate panel, remove the film (*clear inside*) and slide it into the hinge track. Before you do this; remove the paper and lightly spray the foam so that it doesn't stick. Lay it on the foam and slide it into the hinge (top) section and then down into the gutter track. Do the same with the next piece.
8. Take the caps and lay them on the bars, center them, fasten with 1/2" screws.
9. Take the silicone gun and seal where the sheets slide into the track. *Inside and out.*

18. VENT INSTALLATION

Take the vent and slide it in the end of the ridge. You will have to remove a rectangular screw in the ridge. Then push it into place and put the screw back in. Now attach manual opener (*picture A*).



Vent Assembly - Exploded View

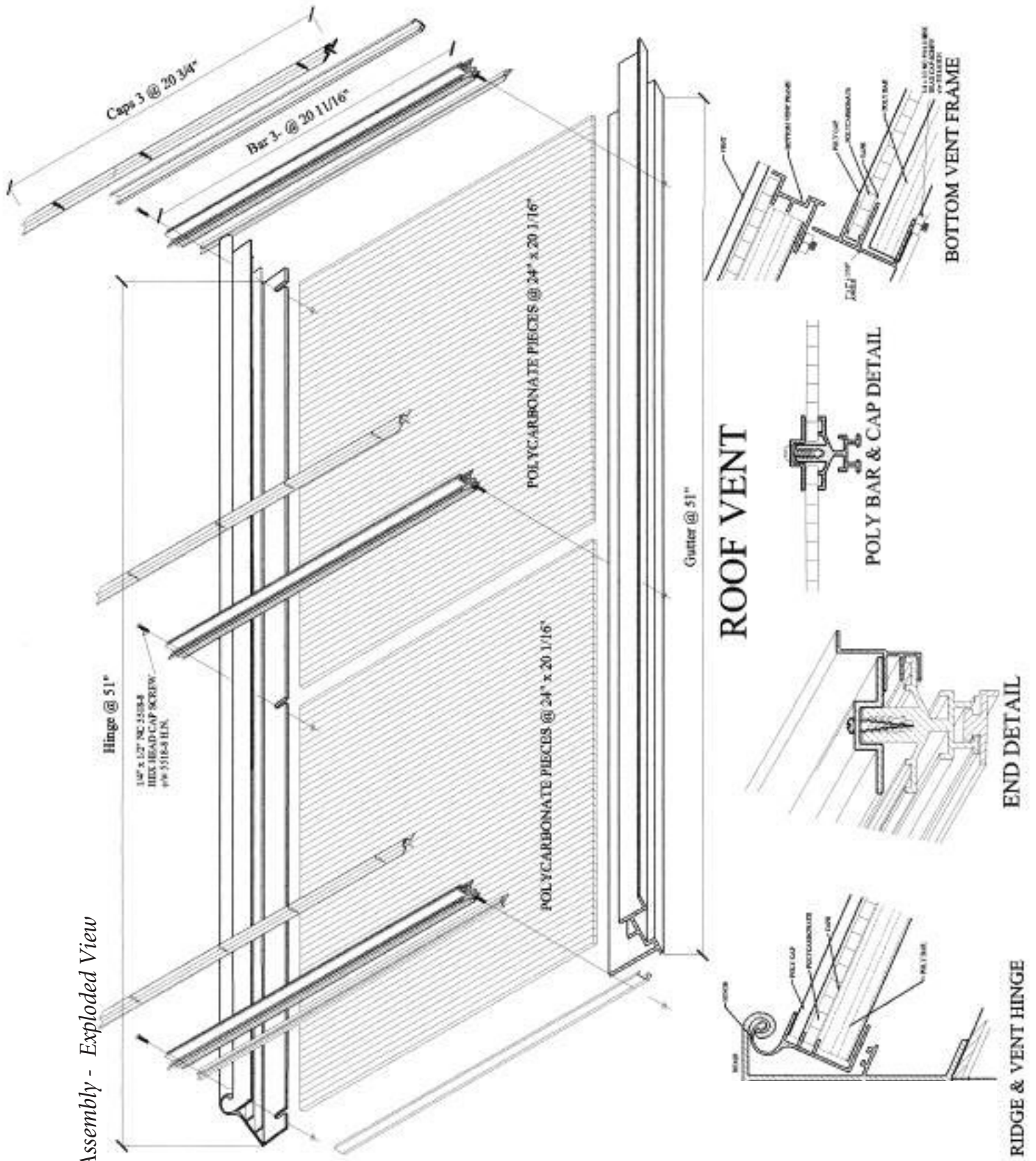

Greenhouse Roof Vent Details



Appendix A – Truss

1. TRUSS ASSEMBLY

(This section is to be used only for greenhouses that are over 14' long.)

Trusses are usually installed after the sides, base, front, back and ridge are bolted together. Make sure that the greenhouse is temporarily braced (*see 4A on Aluminum Frame Assembly*).

- A. Lay the truss piece in the shape of an end wall.
- B. Slide the center pieces into the top of the truss and bolt them together. **1**, **2** and **3** (*lean to models do not have a center piece – see next page*).
- C. Slide the truss feet into the bottom of the truss and bolt them together. **4** and **5**.
- D. Bolt on the cross brace (*if required*) **6**.

2. TRUSS ASSEMBLY & INSTALLATION (IF REQUIRED)

The next step takes two people, one on each side. Carry the truss to the center of the greenhouse and put the feet on your foundation between the side base/sill **7**. Lift the top of the truss towards the ridge and bolt it on **8**. Use the notch on either side of the center. (*For lean to installations line up the top of the truss 1⁵/₁₆" off-centre of roof glazing bar and temporarily fasten with a screw to the wall. This should be permanently lagged to the wall after greenhouse is square and the purlin has no sags at the truss. The gap between the underside of the bar and top of the truss should be 3."*)

Remove the truss bracket from the truss. (*It may also be in a plastic bag.*) Unbolt the bar from the base. Slide the truss bracket into the bottom of the glass bar (*long bar*) **9** & **10** and slide it to the place where there is a 9/64" hole drilled into the truss. Fasten it with a screw. If the hole does not line up, you may have to drill a new hole in the truss bracket **11**. Do this after all the glass bars have been bolted together. To fasten the truss to the foundation, use 1/4" x 2" leg bolts.



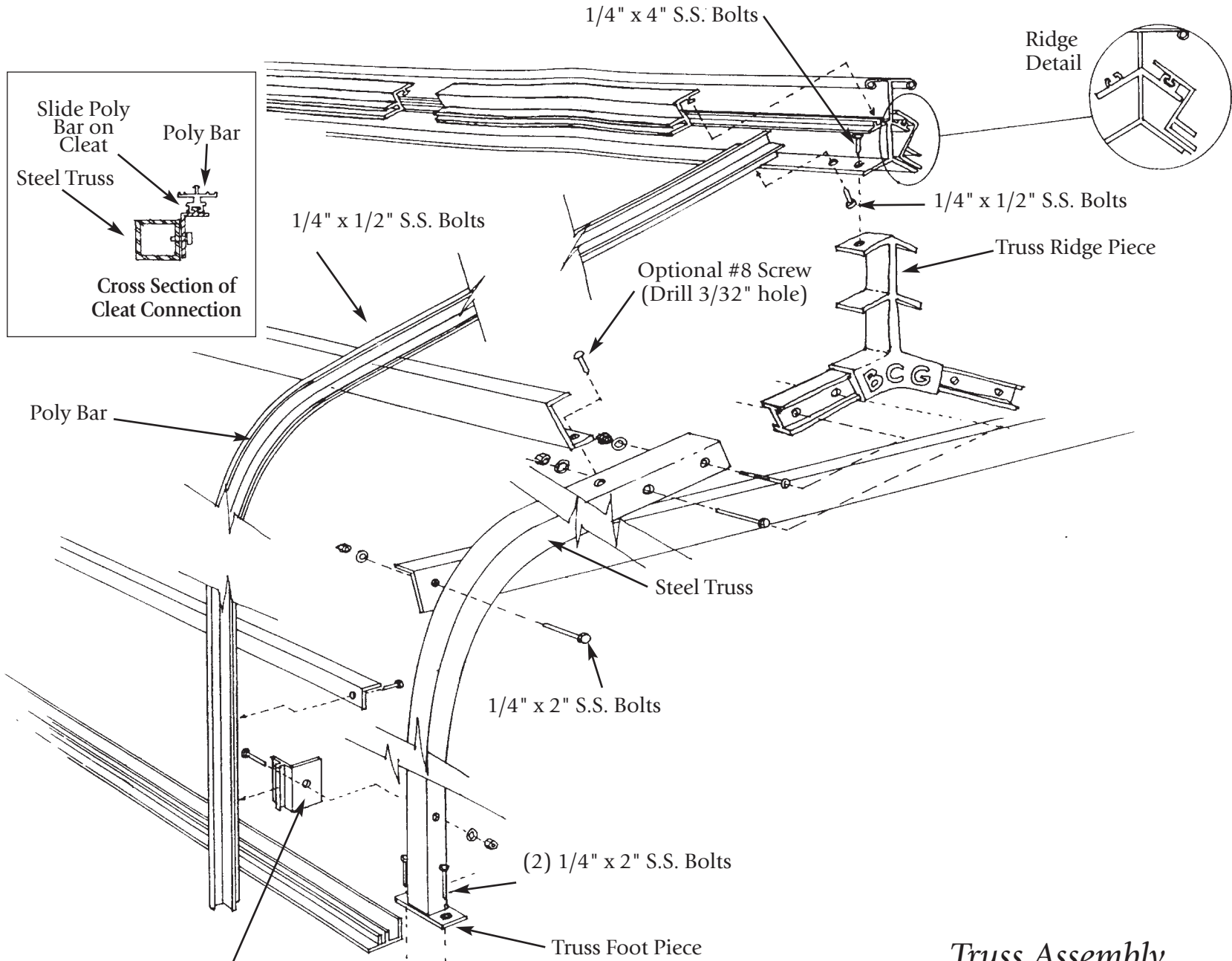

Drill 5/32" Hole & Fasten with #8 Teck Screw

Truss Assembly

Appendix B – Vent Opener

INSTALLING THE BAYLISS AUTOMATIC VENT OPENERS

Detailed instructions are included in the box with the control (there are a few extra parts). Use #8 stainless steel screws to fasten the Bayliss and the vent sill ① and the vent ②. All holes are already drilled.

After the Bayliss is fastened in place, install the threaded adjuster into the swivel block. This is made easier by lifting the vent with one hand until the piston rod only projects 1/2" through the swivel block.

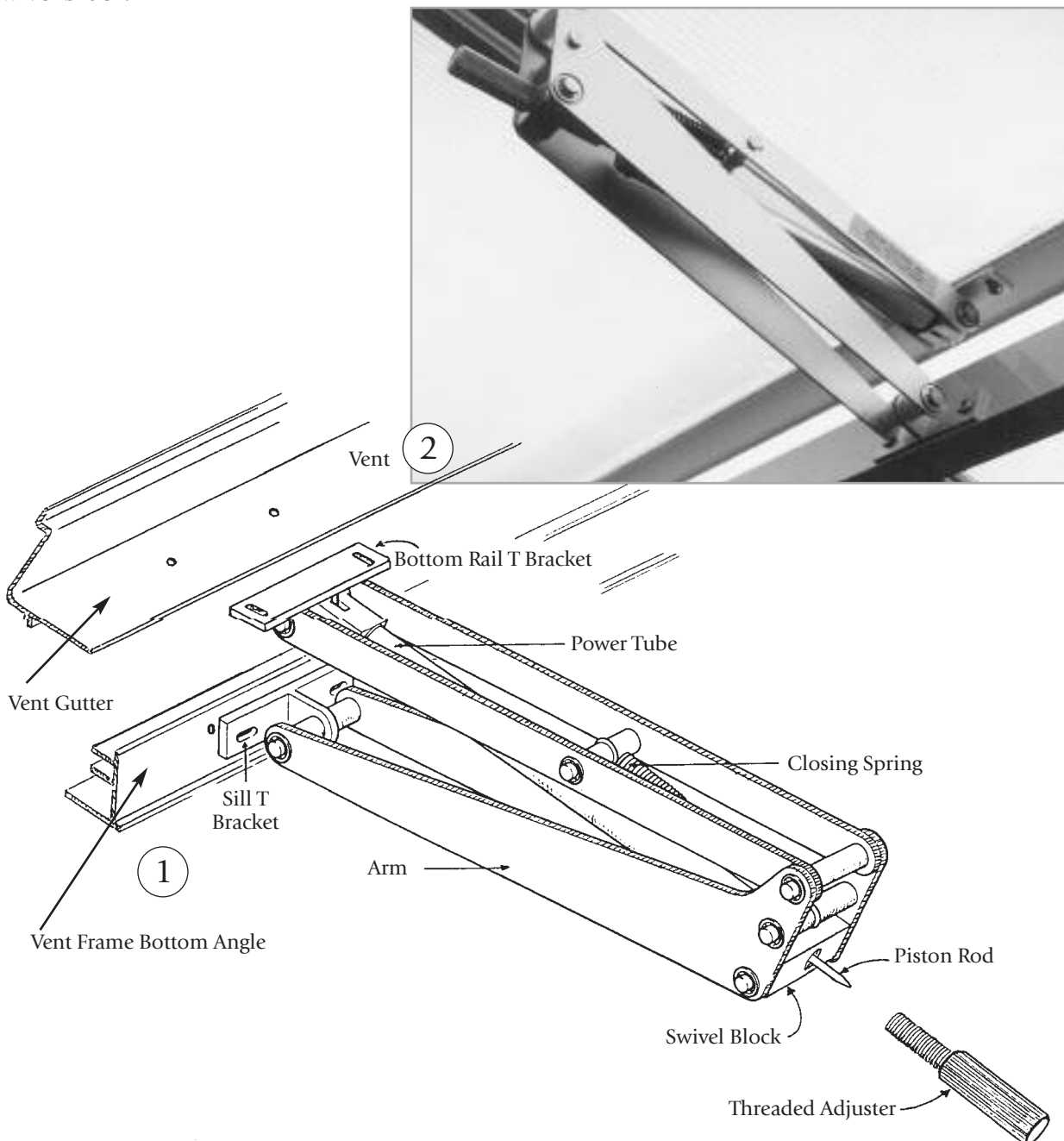

Appendix C – Motorized Intake Shutter

INTAKE SHUTTER ASSEMBLY

Inside View

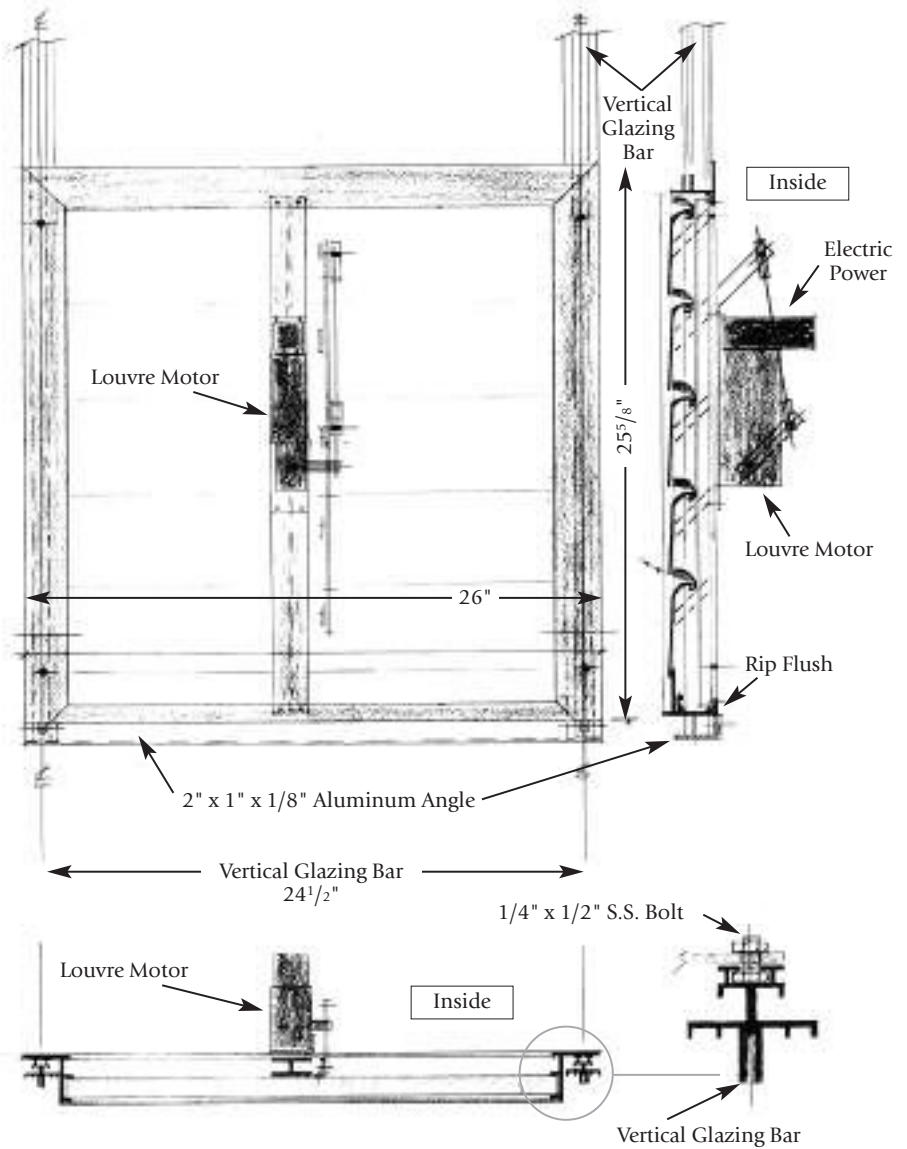

Outside View



Appendix D – Exhaust Fans

INTAKE SHUTTER ASSEMBLY

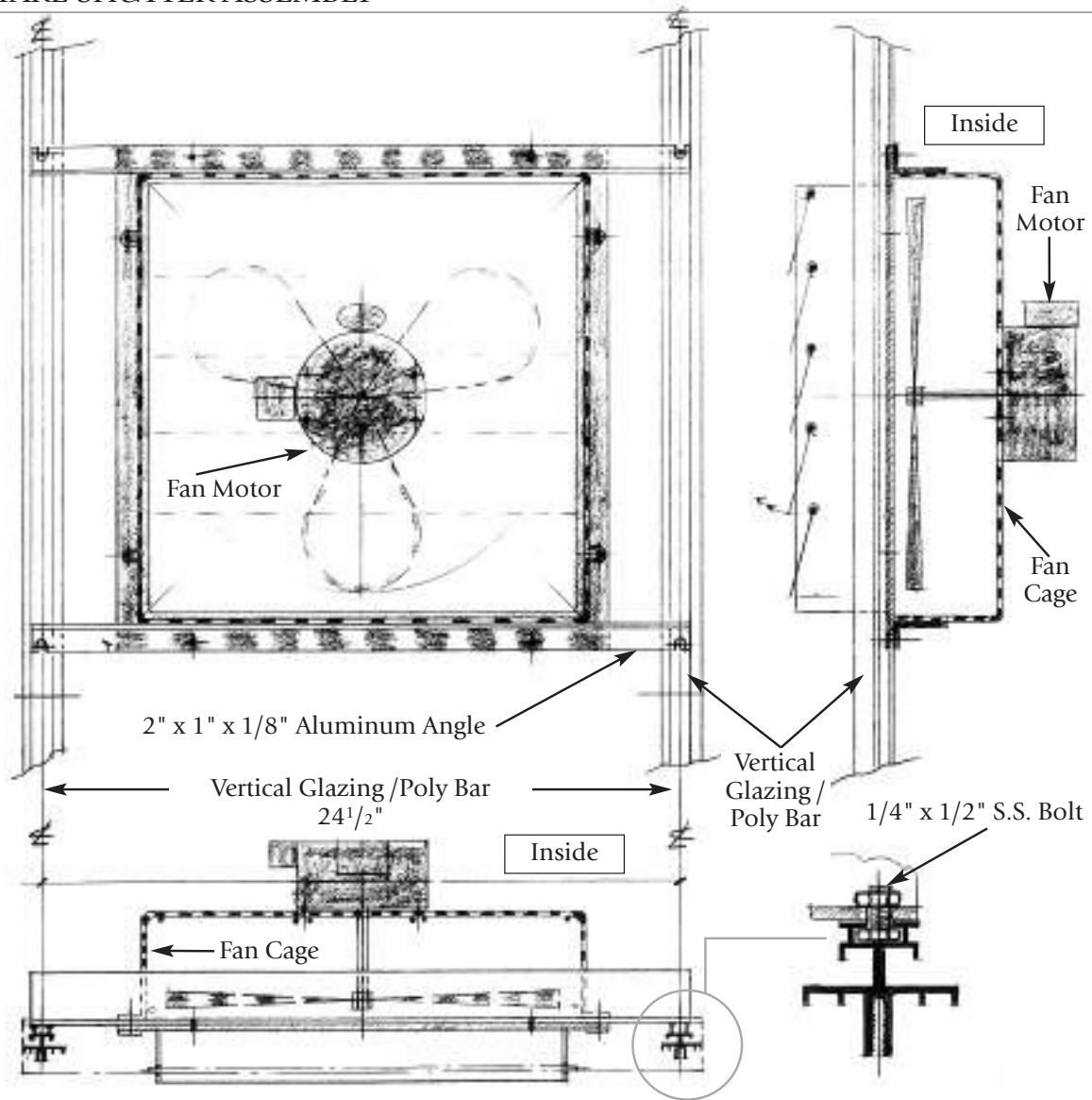

Appendix E – Side Vent

GLASS OR POLYCARBONATE SIDE VENT ASSEMBLY

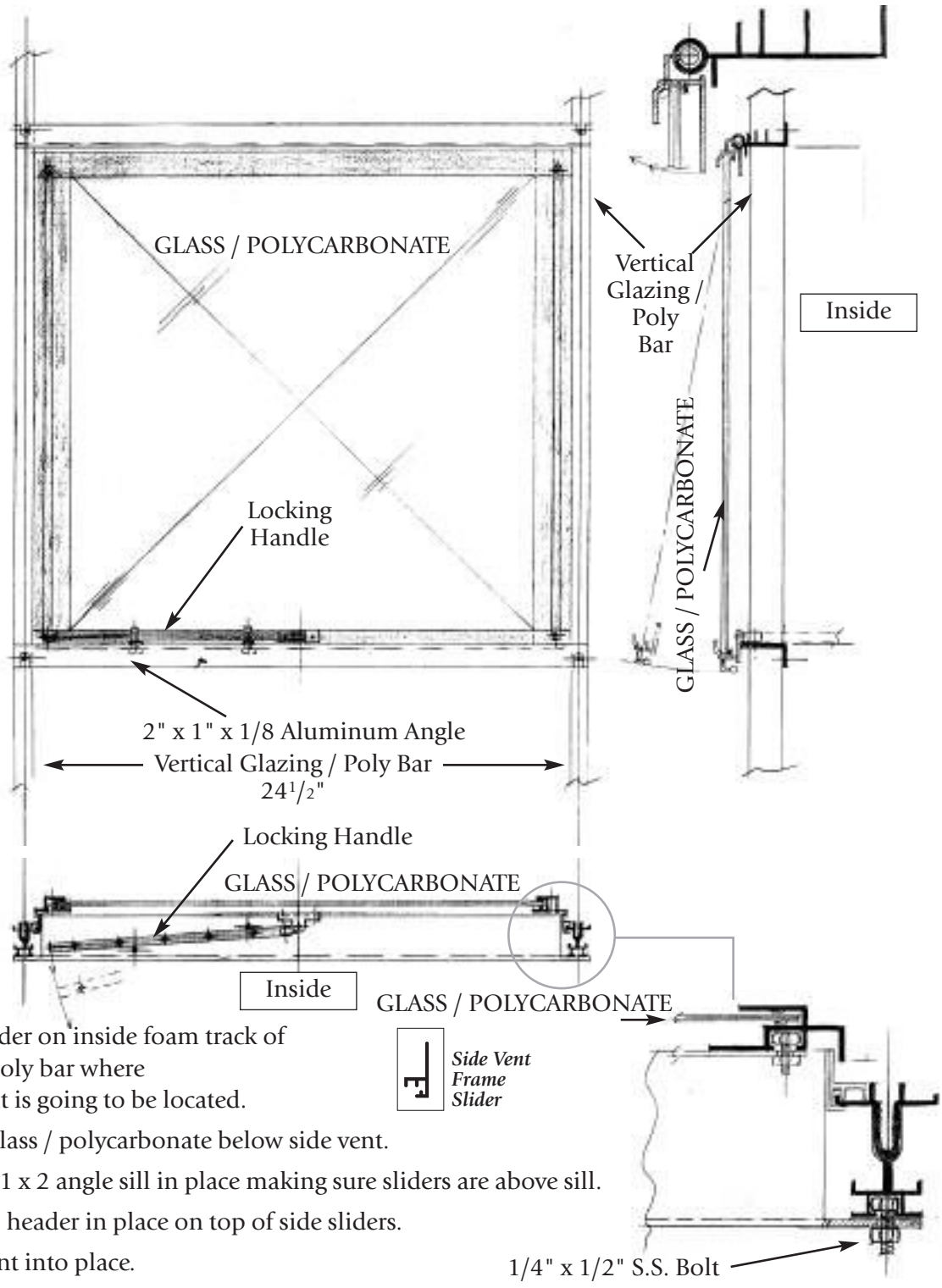

1. Slide slider on inside foam track of glass / poly bar where side vent is going to be located.
2. Install glass / polycarbonate below side vent.
3. Bolt on 1 x 2 angle sill in place making sure sliders are above sill.
4. Bolt top header in place on top of side sliders.
5. Slide vent into place.
6. Install automatic or manual opener.

Appendix E – Side Vent CONTINUED

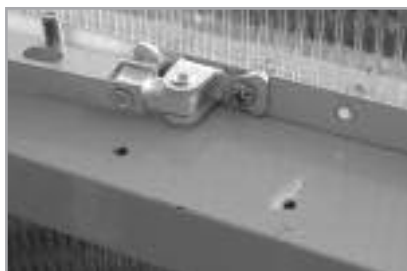
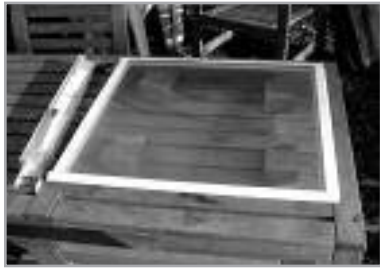

Appendix F – Glass Louvre

GLASS OR POLYCARBONATE GLASS LOUVRE ASSEMBLY



Appendix G – Diagonal Brace

Diagonal Braces are used for larger greenhouses – 16" and up.

INSTALLATION

1. Unwrap the brace, loosen up the bolts on the ends and turn the angles. **#1**
2. Take the end of the brace with the straight angle and bolt it to the end wall. **#2**
3. The other end is fastened to the ridge. You can use a self-drilling screw (supplied) or pre-drill the hole using 9/16" drill bit. **#3**



Appendix H – Cedar Bench

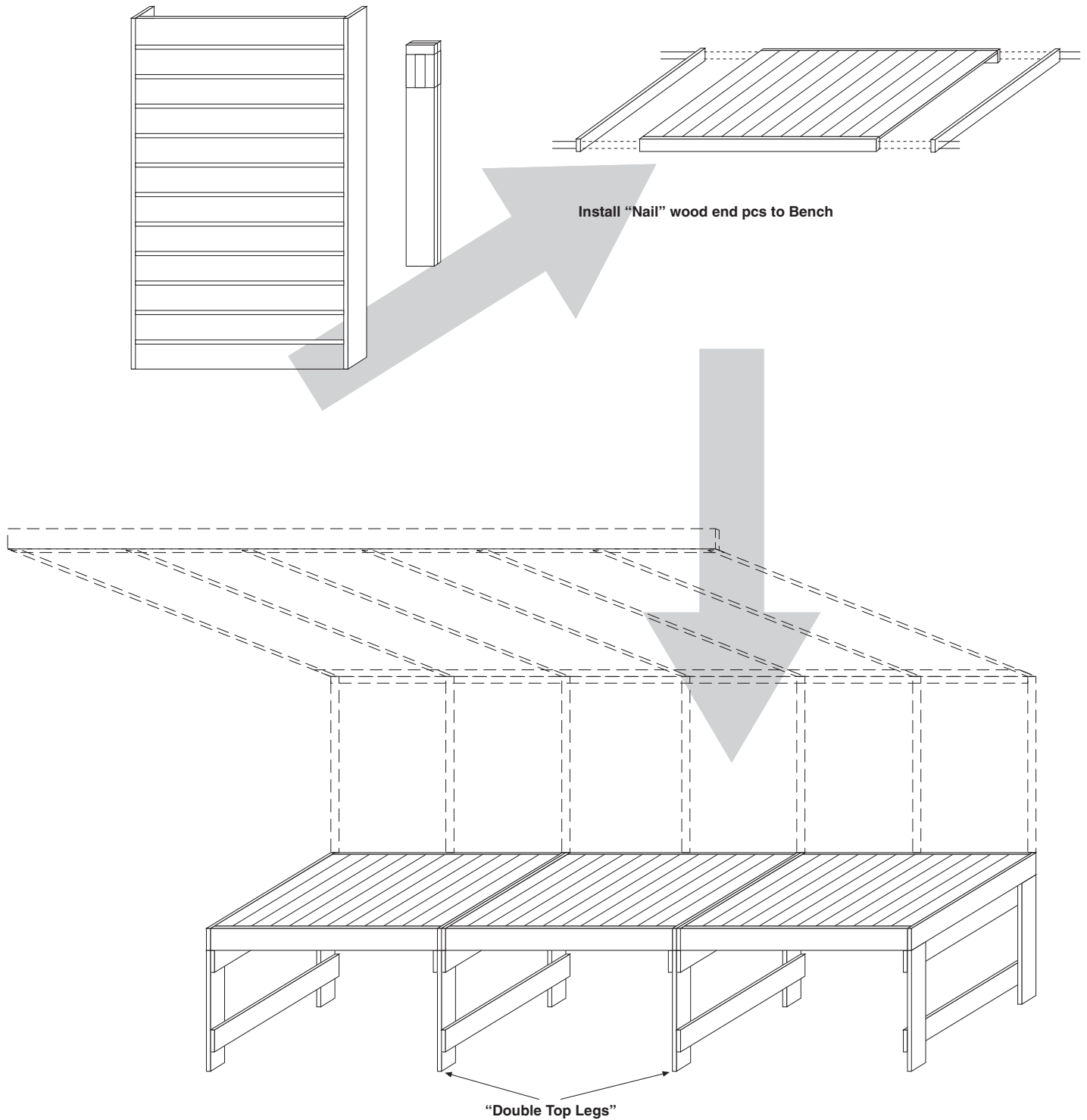

Appendix I – Greenhouse Bench

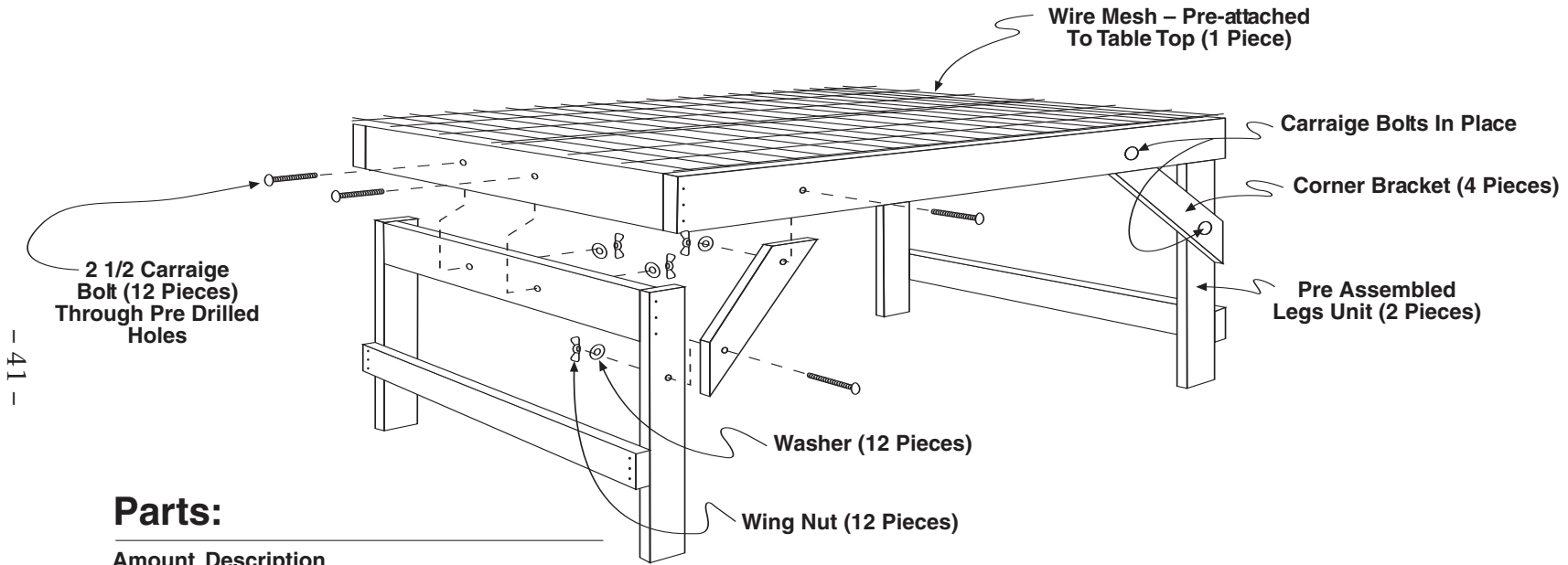

Parts:

Amount	Description
1	– Table Top = W/ Pre-attached Wire Mesh Plastic Coated W/Guide Holes
2	– Leg Units = Pre-assembled W/ Guide Holes
4	– Corner Brackets = W/ Guide Holes
1 Bag	– Contains: 12 – 2 1/2 Carrage Bolts 12 – Washers 12 – Wing Nuts

Appendix J – Roof Vent Screen

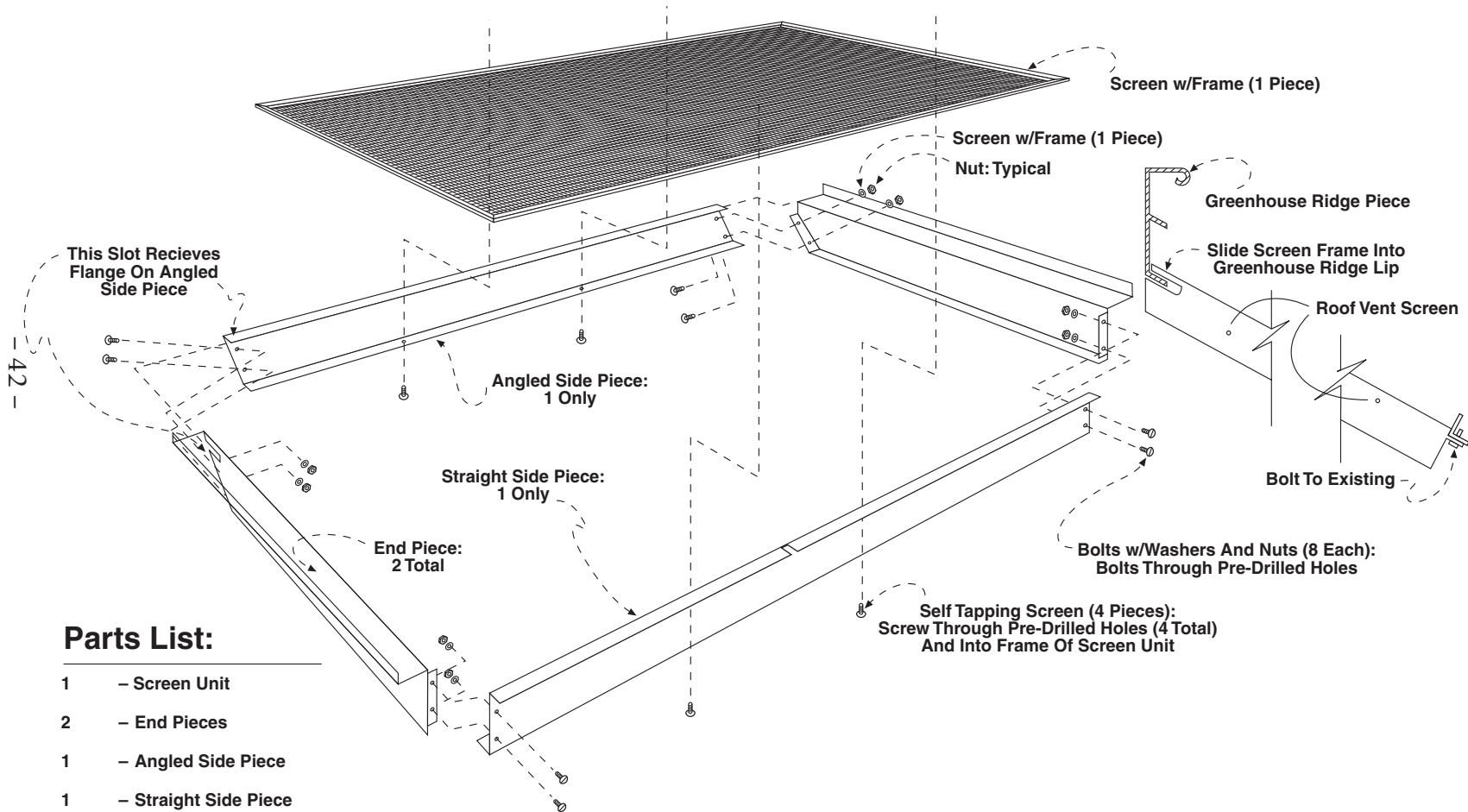

Parts List:

- 1 – Screen Unit
- 2 – End Pieces
- 1 – Angled Side Piece
- 1 – Straight Side Piece
- 1 Bag With: 8 – Bolts
- 8 – Washers
- 8 – Nuts
- 4 – Self Tapping Screws

Appendix K – Side Vent Screen

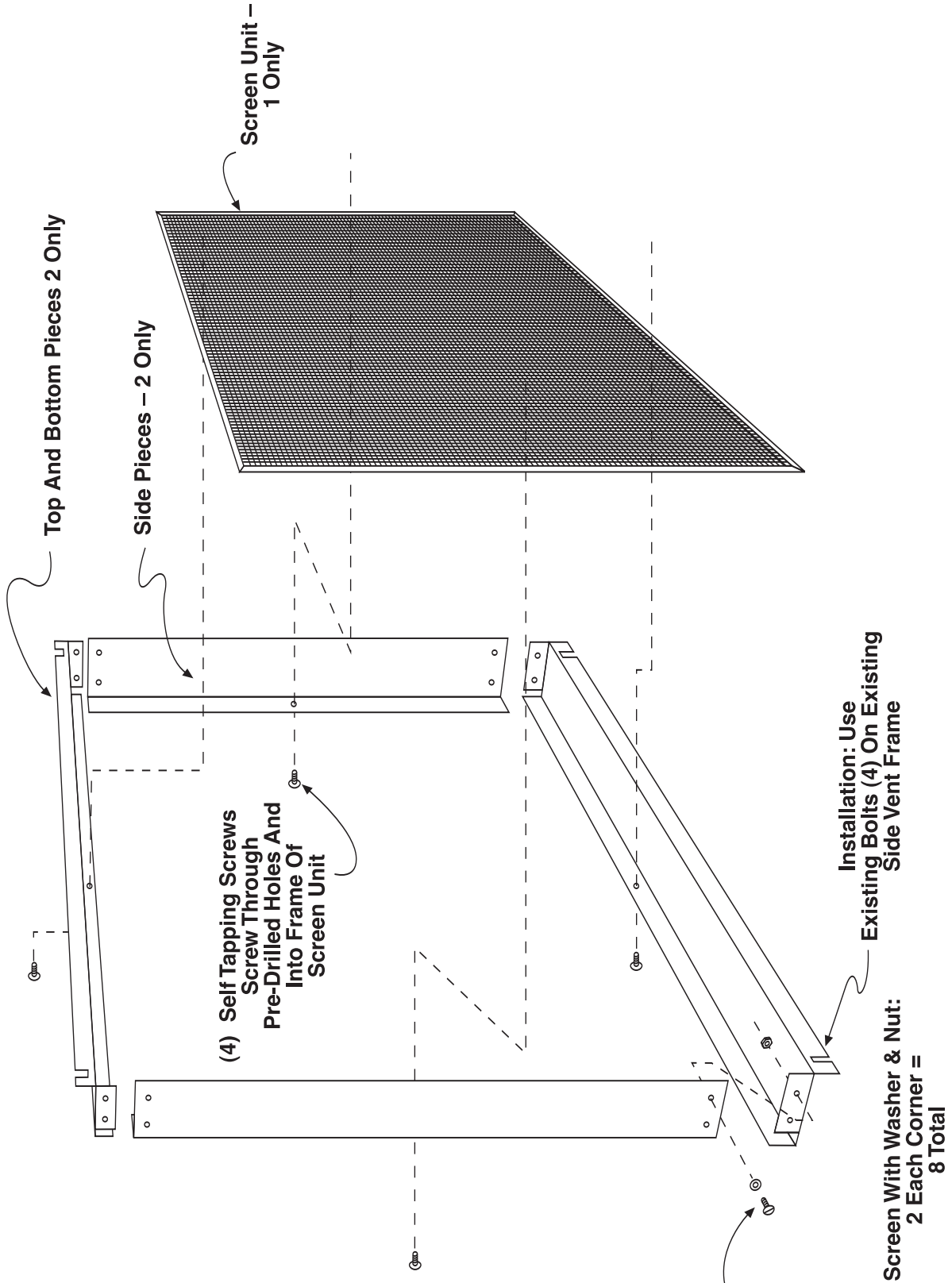

Appendix L – Wire Shelving

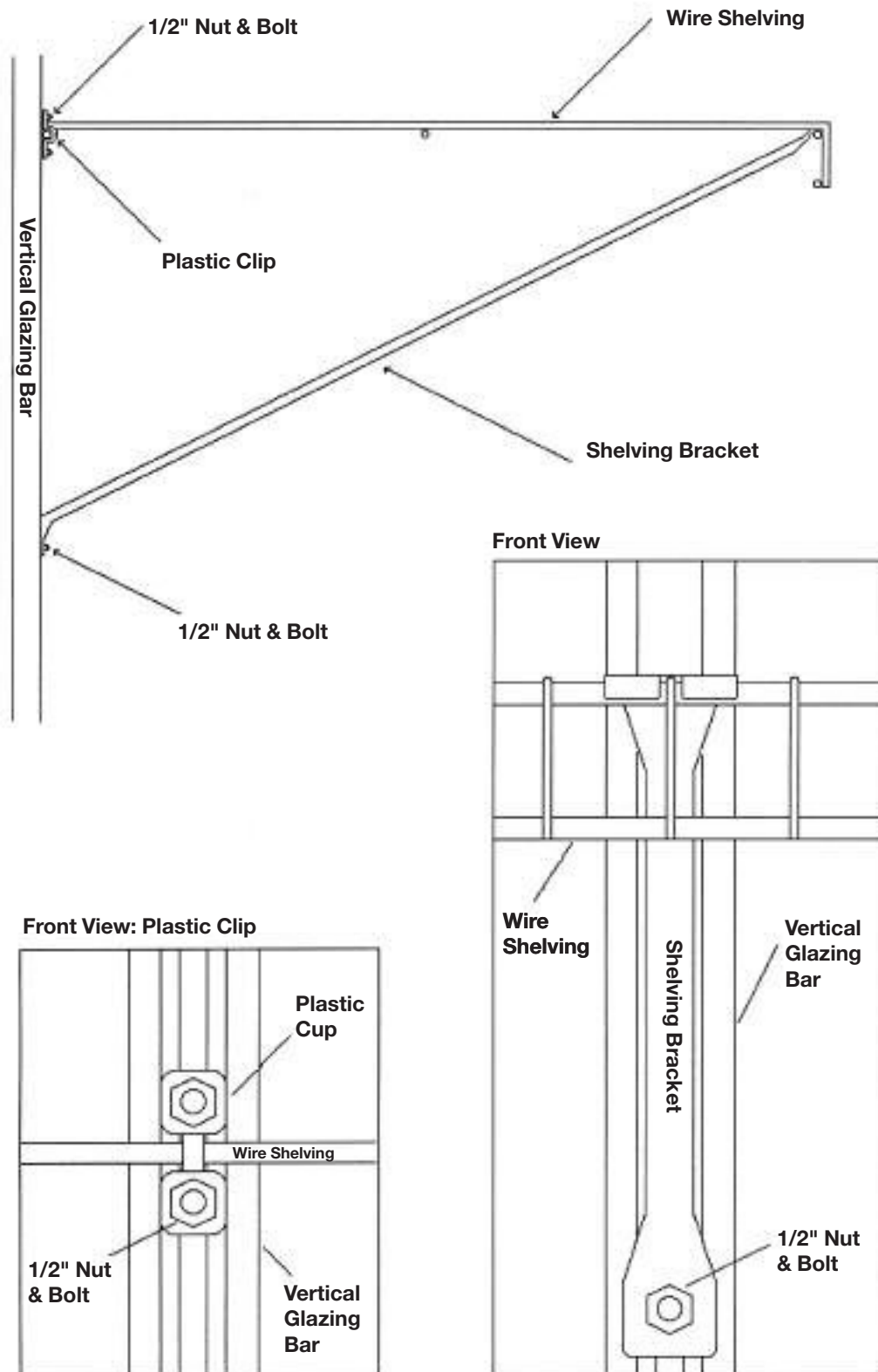

'New' Pressure Treated Wood

WHAT IS NEW ABOUT PRESSURE TREATED WOOD?

As of January 2005, the chemicals used in pressure treated wood have been changed. Previous wood was treated with arsenic. However due to the potential long term health hazards this has been discontinued. New pressure treated wood is treated with copper.

The copper in the 'new' wood will be CORROSIVE TO ALUMINUM as well as other metals.

What are 'Greenhouse Friendly' solutions to the new pressure treated wood?

- 1 If you are using the new pressure treated wood, you must place a barrier between the wood and your aluminum frame. Popular barriers include 10 mil thick plastic sheeting, steel weather flashing, a rubber or foam weather membrane, or a row of weather resistant non-treated wood such as cedar or hemlock.
- 2 Other weather resistant non-treated woods are popular alternatives to pressure treated wood. These contain no harmful chemicals and will outlast pressure treated wood. Cedar timbers are a popular choice for greenhouse foundations.
- 3 Concrete foundations have always been suitable foundation alternatives for greenhouses. They can vary from poured concrete slabs, poured concrete perimeter walls to concrete block walls. Although these are usually more costly than wood alternatives, they have the benefit of lasting a lifetime. As they are usually considered a permanent foundation, it is important to check with your building codes to determine what you are able to build.

If you have any questions about using the 'New' pressure treated wood in conjunction with our aluminum greenhouses, please contact our office at 1-888-391-4433.



At this point, stand back and enjoy your workmanship.

*Your Cross Country Greenhouse
should now be closed in and ready for use.*

Congratulations!